

ePOS-Print XML User's Manual

Overview

Describes the features and development environment.

Sample Program (XML Print Service)

Describes how to use the sample program and how to build a system.

Programming Guide (XML Print Service)

Describes how to write programs in Web application development.

XML Reference

Describes the ePOS-Print XML.

Appendix

Cautions

- No part of this document may be reproduced, stored in a retrieval system, or transmitted in any form or by any means, electronic, mechanical, photocopying, recording, or otherwise, without the prior written permission of Seiko Epson Corporation.
- The contents of this document are subject to change without notice. Please contact us for the latest information.
- While every precaution has taken in the preparation of this document, Seiko Epson Corporation assumes no responsibility for errors or omissions.
- Neither is any liability assumed for damages resulting from the use of the information contained herein.
- Neither Seiko Epson Corporation nor its affiliates shall be liable to the purchaser of this product or third parties for damages, losses, costs, or expenses incurred by the purchaser or third parties as a result of: accident, misuse, or abuse of this product or unauthorized modifications, repairs, or alterations to this product, or (excluding the U.S.) failure to strictly comply with Seiko Epson Corporation's operating and maintenance instructions.
- Seiko Epson Corporation shall not be liable against any damages or problems arising from the use of any options or any consumable products other than those designated as Original Epson Products or Epson Approved Products by Seiko Epson Corporation.

Trademarks

EPSON is a registered trademark of Seiko Epson Corporation.

Exceed Your Vision and ESC/POS are registered trademarks or trademarks of Seiko Epson Corporation.

Microsoft®, Windows®, Visual Studio®, Silverlight® and Internet Explorer® are either registered trademarks or trademarks of Microsoft Corporation in the United States and other countries.

Android™ and Google Chrome™ are either registered trademarks or trademarks of Google Inc. in the United States and other countries.

Apple®, Mac OS® and Xcode® are either registered trademarks or trademarks of Apple Inc. in the United States and other countries.

IOS® is registered trademarks or trademarks of Cisco in the United States and other countries.

Flash®, Flex™ are either registered trademarks or trademarks of Adobe Systems Incorporated in the United States and other countries.

Java™ is a registered trademark of Oracle Corporation, its subsidiaries, and affiliates in the U.S. and other countries.

Eclipse® is a trademark or registered trademark of Eclipse Foundation, Inc.

FileMaker is a trademark of FileMaker, Inc., registered in the U.S. and other countries.

QR Code® is a registered trademark of DENSO Wave Incorporated.

All other trademarks are the property of their respective owners and used for identification purpose only.

ESC/POS® Proprietary Command System

Epson took the initiative by introducing ESC/POS, a proprietary POS printer command system, which includes patented or patent pending commands and enables versatile POS system construction with high scalability.

Compatible with all types of Epson POS printers and displays, this proprietary control system also offers the flexibility to easily make future upgrades. Its popularity is worldwide.



ESC/POS is designed to reduce the processing load on the host computer in POS environments. It comprises a set of highly functional and efficient commands that enables the full realization of the potential of printers.

© Seiko Epson Corporation 2012-2015. All rights reserved.

For Safety

Key to Symbols

The symbols in this manual are identified by their level of importance, as defined below. Read the following carefully before handling the product.

	Provides information that must be observed to avoid damage to your equipment or a malfunction.
	Provides important information and useful tips.

Restriction of Use

When this product is used for applications requiring high reliability/safety such as transportation devices related to aviation, rail, marine, automotive etc.; disaster prevention devices; various safety devices etc; or functional/precision devices etc, you should use this product only after giving consideration to including fail-safes and redundancies into your design to maintain safety and total system reliability. Because this product was not intended for use in applications requiring extremely high reliability/safety such as aerospace equipment, main communication equipment, nuclear power control equipment, or medical equipment related to direct medical care etc, please make your own judgment on this product's suitability after a full evaluation.

About this Manual

Aim of the Manual

This manual is aimed to provide developers with information required for developing and designing applications using ePOS-Print XML.

In this manual, "ePOS-Print supported printer" is a generic term for the TM-DT series/TM-i series and TM printers that support the ePOS-Print XML.

The TM-DT series in this manual is a generic term for the following printers.

- TM-H6000IV-DT
- TM-T70II-DT
- TM-T88V-DT

The TM-i series in this manual is a generic term for the following printers.

- TM-L90-i
- TM-T20II-i
- TM-T70-i
- TM-T82II-i
- TM-T83II-i
- TM-T88V-i
- TM-U220-i

Manual Content

The manual is made up of the following sections:

Chapter 1	Overview
Chapter 2	Sample Program (XML Print Service)
Chapter 3	Programming Guide (XML Print Service)
Chapter 4	XML Reference
Appendix	ePOS-Print Editor

Contents

■ For Safety	3
Key to Symbols	3
■ Restriction of Use	3
■ About this Manual	4
Aim of the Manual	4
Manual Content	4
■ Contents	5

Overview 9

■ Overview	9
■ XML Print Service	9
Features	9
Interface Type	10
WSDL(Web Services Description Language)	11
Print Image	11
Operating Environment	12
ePOS-Print Service Versions	14
Restrictions	14
■ XML Reference	15
XML Schemas	15
Namespace	15
Command Type	16
■ Provided Article	17
Package	17
Manual	17
Sample Program	17
Download	18

Sample Program (XML Print Service) 19

■ Overview	19
Sample Program Overview	19
■ Environment	20
■ Operating Environment	21
■ Environment Settings	22
ePOS-Print Settings	23
Editing the Sample Program	25
Registering the Sample Program	25

■ Environment Settings in Other Execution Environments	26
HTML5 (To Build a Web Server on Windows/Linux).....	26
Java	27
Windows (Visual Basic .NET)	28
Silverlight	29
Flash	30
Android	31
Windows CE	33
iOS	37
Windows Store Apps.....	38

Programming Guide (XML Print Service)..... 39

■ How to Use XML Schemas	39
Visual Studio	39
Eclipse	42
■ ePOS-Print XML	43
Print Mode	43
Programming Flow.....	43
Print Document Creation	44
Transmission of Print Document.....	48
Reception of Print Result.....	51
Checking the Printer Status	53
■ Specifying the Print Job ID from the Application	54
■ Using the Spooler Function	55
Programming Example	56
■ Printing in Other Environments	58
.NET Framework.....	58
Java	60

XML Reference..... 61

■ Element List	61
■ Root Element	62
<epos-print>	62
<response>	63
■ Element	66
<text>	66
<feed>	72
<image>	74
<logo>.....	76
<barcode>	77
<symbol>	81
<hline>	86
<vline-begin>	87
<vline-end>	88
<page>.....	89
<area>	90
<direction>	91

<position>.....	92
<line>	93
<rectangle>.....	94
<cut>	95
<pulse>.....	96
<sound>	97
<command>	99
<layout>	100
<recovery>.....	104
<reset>.....	105

■ Support Information by Printer 106

TM-H6000IV-DT	106
TM-L90-i/ TM-L90	108
TM-P20	110
TM-P60II/ TM-P60II with Peeler	112
TM-P80	114
TM-T20.....	116
TM-T20II-i/ TM-T20II	117
TM-T70-i/ TM-T70.....	119
TM-T70-i/ TM-T70 (Multi-language model)	121
TM-T70II-DT/ TM-T70II	123
TM-T82II-i/ TM-T82II	125
TM-T83II-i/ TM-T83II	127
TM-T88IV	129
TM-T88V-DT/ TM-T88V-i/ TM-T88V	131
TM-T90.....	133
TM-U220-i/ TM-U220	135

Appendix..... 137

■ ePOS-Print Editor..... 137

ePOS-Print Editor Operating Environment	137
Environment Setting Procedure.....	137
Setting	139
Creating a Sample Code	140
Encoding Graphic Data	145



Overview

This chapter describes the features of and the specifications for ePOS-Print.

Overview

ePOS-Print is an Epson's unique printing function that uses XML and Web Service.

This function creates request messages in XML format using the application on devices such as computers, smart phones, and tablets, and performs printing to a TM printer on the network using Web Service.

This document is made up of the following sections:

- XML Print Service (p.9)
- XML Reference (p.15)

For details about the provided articles, refer to [Provided Article \(p.17\)](#).

Print data can be created in ePOS-Print XML format also with Server Direct Print. For details, refer to [XML Reference \(p.61\)](#).

XML Print Service

ePOS-Print XML allows printing to ePOS-Print supported TM printer from applications in an environment or on OS where HTTP communication is possible. ePOS-Print XML embedded into native applications on smart phones and tablet terminals makes it possible to print from such devices.

When a print document is sent from a host to an ePOS-Print supported TM printer using SOAP/HTTP, the ePOS-Print supported TM printer performs printing and returns a response document.

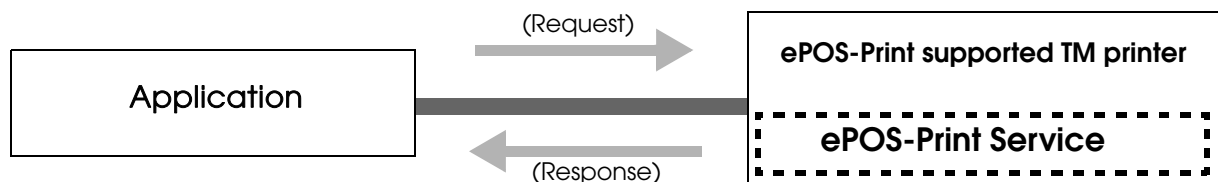

Features

- ❑ Allows printing from SOAP/HTTP-supported devices. Not OS-dependent.
- ❑ Installation of drivers and plug-ins is not required.
- ❑ No computers or servers are required for printing.
- ❑ In case of TM-DT series/TM-i series, it can print to other TM printer via TM intelligent printer.
- ❑ Automatically checks the status of the TM printer before printing. There is no need for checking the status of the TM printer in advance.
- ❑ Does not respond to a printer's function to automatically send its status (Auto Status Back). Instead, capable of sending an empty print command and checking the status of the TM printer based on the result of command transmission.
- ❑ To change the printer settings, utility programs dedicated to each printer or other utility programs should be used.
- ❑ Capable of obtaining the printer status even when the printer is offline.

Interface Type

- ❑ [SOAP/HTTP Interface \(p.10\)](#)
- ❑ [SOAP/HTTP Interface \(WSDL supported\) \(p.10\)](#)
- ❑ [Interface for FileMaker® \(p.11\)](#)

SOAP/HTTP Interface

When a print document is sent from an application to ePOS-Print Service using SOAP/HTTP, ePOS-Print Service performs printing and returns a response document.

Specification

Item	Description
End point address	http://(IP address of the ePOS-Print supported TM printer)/cgi-bin/epos/service.cgi?devid=(device ID)&timeout=(timeout time)
Request message	A SOAP message is sent against a HTTP POST method request. One print document is specified in the SOAP body.
Response message	A SOAP message is returned against a HTTP POST method response. A response document is put in the SOAP body.

SOAP/HTTP Interface (WSDL supported)

When a print document is sent from an application to ePOS-Print Service using SOAP/HTTP, ePOS-Print Service performs printing and returns a response document. Job ID can be specified.

(ePOS-Print Service Ver.4.1 or later versions supported.)

Specification

Item	Description
End point address	http://(IP address of the ePOS-Print supported TM printer)/cgi-bin/epos/service.cgi
Request message	A SOAP message is sent against a HTTP POST method request. In the SOAP header, the device ID, timeout time, and job ID can be specified. One print document is specified in the SOAP body.
Response message	A SOAP message is returned against a HTTP POST method response. A device ID and a job ID are put in the SOAP header. A response document is put in the SOAP body.

Interface for FileMaker®

This interface uses the HTTP POST function of FileMaker for printing.
(ePOS-Print Service Ver.4.1 or later versions supported.)

Specification

Item	Description
End point address	httppost://(IP address of the ePOS-Print supported TM printer)/cgi-bin/epos/service.cgi?printdata=(SOAP message)
Request message	A SOAP message is sent against a request in the HTTP POST function of FileMaker. In the SOAP header, the device ID, timeout time, and job ID can be specified. One print document is specified in the SOAP body.
Response message	A SOAP message is returned against a response in the HTTP POST function of FileMaker. A device ID and a job ID are put in the SOAP header. A response document is put in the SOAP body.

WSDL(Web Services Description Language)

WSDL defines the SOAP/HTTP interface in XML Print Service.

This allows you to generate client codes (proxy class) from WSDL by using the tool provided in the development environment.

File name: epos-print-4.x.x.wsdl
epos-print-4.x.x.xsd

For details, refer to [Printing in Other Environments \(p.58\)](#).

Print Image

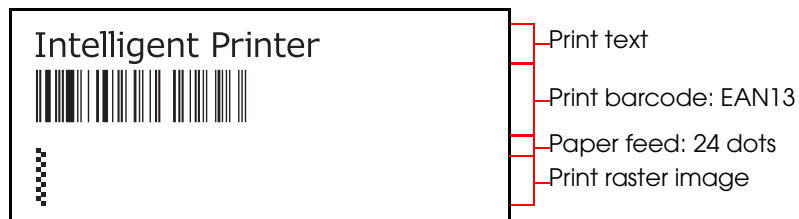

Operating Environment

Application Environment

An environment in which HTTP communication is possible and XML documents can be handled

- OS (Example: iOS/ Android™/ Windows CE/ Windows/ Linux/ Mac OS, etc.)
- HTML5-supported browser, Flex, Silverlight
- Java, .NET Framework

Device

A device capable of HTTP communication by connecting to the network.

(Example: smart phones, tablet terminals, computers, etc.)

Development Environment

An editor program capable of editing XML documents.

(Example: Visual Studio/Eclipse, etc.)

ePOS-Print Supported Printer

For differences in functions according to printer type, refer to [Support Information by Printer \(p.106\)](#).

TM-DT Series

- TM-H6000IV-DT (Receipt printer only)
- TM-T70II-DT
- TM-T88V-DT

TM-i Series

- TM-L90-i
- TM-T20II-i
- TM-T70-i
- TM-T82II-i
- TM-T83II-i
- TM-T88V-i
- TM-U220-i

TM Printer

- Following printers with the UB-R04 embedded
 - TM-T20
 - TM-T20II
 - TM-L90
 - TM-T70
 - TM-T70II
 - TM-T82II
 - TM-T83II
 - TM-T88IV
 - TM-T88V
 - TM-T90
 - TM-U220
- TM-P20 (Wi-Fi® model)
- TM-P60II (Wi-Fi model)
- TM-P60II with Peeler (Wi-Fi model)
- TM-P80 (Wi-Fi model)



ePOS-Print in the TM printer must be turned to "Enable". It is set to "Disable" by factory default. You cannot control ePOS-Print if it is disabled. For details, refer to [Support Information by Printer \(p.106\)](#).

Printer Functions

Depending on the printer type and TM-DT software/TM-i firmware version being used, the functions you can use with ePOS-Print XML differ. For details, see the following.

Printer Type	Network printer control	Spooler/Print forwarding	HTTPS Communication
TM-DT Series	● *	TM-DT Software Ver.3.0 or later	TM-DT Software Ver.2.5 or later
TM-i Series	● *	TM-i Firmware Ver.4.1 or later	TM-i Firmware Ver.4.3 or later
TM Printer	-	-	-

* Available TM printers are different depending on the TM-DT software version installed in the product. For details, refer to Technical Reference Guide for each printer.

ePOS-Print Service Versions

The ePOS-Print Service version is supported as follows.

ePOS-Print Service	TM-DT Software	TM-i Firmware	EPSON TMNet WebConfig	
			Wi-Fi Model	UB-R04
1.2	-	1.2x	-	-
2.0	-	2.0x	-	-
2.1	-	2.1x	-	-
2.2	2.0x	-	2.2	2.2
3.0	2.2x, 2.5x	3.0x, 3.1x, 4.0x	3.0	3.0
3.2	-	-	3.2	-
4.1	3.0x	4.1x, 4.3x	-	-



If XML element of newly added is used on unsupported models, schema error is returned and printing cannot be done. The latest version of the XML Schema is recommended regardless of ePOS-Print Service version installed on a printer. XML Schema is bundled with the sample program. For details, refer to [Provided Article \(p.17\)](#).

Restrictions

- ❑ The drawer and the buzzer cannot be used together.
- ❑ The buzzer function cannot be used if the printer is not provided with the buzzer.
- ❑ When multiple tones are set for raster images, intermitting printing may occur because the amount of data to print increases and white stripes may appear in the print result.
- ❑ The scan quality of barcodes/2D-codes printed as multiple-tone raster images cannot be guaranteed. Print them as two-tone images.
- ❑ If printing was cancelled, perform the following settings to clear the data left in the printer. (in ePOS-Print Service Ver.3.0 and later)
 - In the printer DIP switches (memory switches), configure the Busy condition only for the receive buffer full.
 - Disable the command execution (offline). (TM-P60II, TM-P80)

XML Reference

ePOS-Print XML is a POS printer command system that defines the major features of the ESC/POS command system using XML.

XML Schemas

The ePOS-Print XML syntax is defined by W3C XML Schemas.

XML schemas help applications strictly validate XML documents using the XML API of the operating environment. In addition, application developers can efficiently create XML documents using the XML document editing support function of the integrated development environment.

File name : epos-print-4.x.x.xsd

Namespace

The ePOS-Print XML namespaces and namespace identifiers used in this document are shown as follows:

Identifier	Namespace
(Default)	http://www.epson-pos.com/schemas/2011/03/epos-print
tns	http://www.epson-pos.com/schemas/2011/03/epos-print
xs	http://www.w3.org/2001/XMLSchema

Command Type



The installed functions vary depending on the model. For details, refer to [Support Information by Printer \(p.106\)](#).

Item	Description
Common	Alignment, Rotation, Line Spacing, Page mode
Character	ANK
Character style	Font, Smoothing, Double-width, Double-height, Horizontal scale, Vertical scale, White/Black Reverse, Underline, Emphasized Color, Print position
Paper feed	By Unit, By Line
Raster image	Mono, Multiple-tone
NV logo	Mono, Multiple-tone
Barcode	UPC-A, UPC-E, EAN13(JAN13), EAN8(JAN13), CODE39, ITF,CODABAR(NW-7), CODE93, CODE128, GS1-128, GS1 DataBar
2D-Code	PDF417, QR Code, MaxiCode, GS1 DataBar, Aztec Code, DataMatrix
Line	6 types
Paper cut	No Feed, Feed Cut, Cut Reservation
Drawer Kick-out	Connector, ON Time
Buzzer	7 or 10 Pattern, Repeat
Layout	Paper layout setting
Command	ESC/POS insertion
Response	Print result, Error code, Status
Recovery from an error	Recovery from errors that can be recovered from, Buffer clear
Reset	Printer reset

Provided Article

Package

File name	Description
ePOS-Print_Sample_XML_Vx.x.xE.zip	This is a sample program file.
ePOS-Print_XML_um_en_revx.pdf	This Document.

Manual

- ePOS-Print XML User's Manual (This Document)
- TM-H6000IV-DT Technical Reference Guide
- TM-T70II-DT Technical Reference Guide
- TM-T88V-DT Technical Reference Guide
- TM-L90-i Technical Reference Guide
- TM-P20 Technical Reference Guide
- TM-P60II Technical Reference Guide
- TM-P80 Technical Reference Guide
- TM-T20II-i Technical Reference Guide
- TM-T70-i (TM-i firmware Ver.4 or later) Technical Reference Guide
- TM-T70-i (TM-i firmware Ver.3.x or earlier) Technical Reference Guide
- TM-T82II-i Technical Reference Guide
- TM-T83II-i Technical Reference Guide
- TM-T88V-i (TM-i firmware Ver.4 or later) Technical Reference Guide
- TM-T88V-i (TM-i firmware Ver.3.x or earlier) Technical Reference Guide
- TM-U220-i Technical Reference Guide
- UB-R04 Technical Reference Guide
- Each TM printer Technical Reference Guide

Sample Program

ePOS-Print_Sample_XML_V4.x.xE.zip

Contains the following:

- epos-print-4.x.x.wsdl (ePOS-Print XML Print Service)
- epos-print-4.x.x.xsd (ePOS-Print XML schemas)
- Sample program
(HTML5/ Java/ Windows/ Silverlight/ Flash/Android/ iOS/ Windows CE)
- editor/index.html (ePOS-Print Editor)

Download

For customers in North America, go to the following web site:

<http://www.epsonexpert.com/> and follow the on-screen instructions.

For customers in other countries, go to the following web site:

<https://download.epson-biz.com/?service=pos>

Sample Program (XML Print Service)

This chapter describes the environment settings for using ePOS-Print and how to use the sample program for printing print data that is created with XML Reference from a printer by using XML Print Service.



In this chapter, descriptions are made mainly based on a HTML5 environment. For an environment other than the above, read such descriptions in ways that suit the relevant environment.

Overview

Sample Program Overview

The following screen appears when the sample program starts. Click the (Print) button to execute.

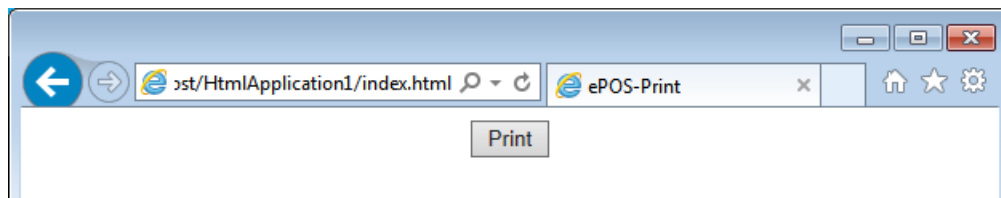

Sample program execution result

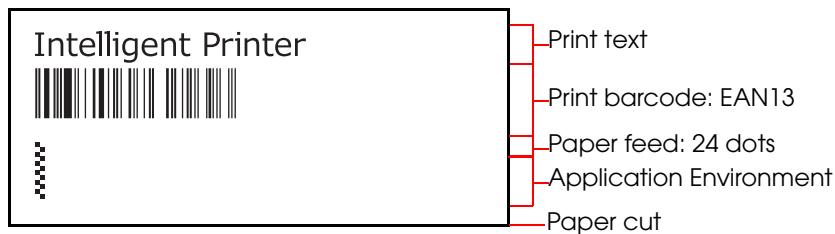

A response message from ePOS-Print supported TM printer

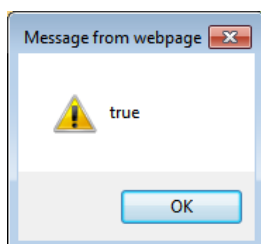

Environment

This section describes the following system: the device's HTML 5-supported browser accesses the sample program uploaded to Web server and then printing is performed. For use in other environments, see ["Environment Settings in Other Execution Environments" on page 26](#).

The following environments are provided for the sample program:

Environment	File Name
HTML5-supported Web browser	HtmlApplication1.zip
Java	JavaProject1.zip
Windows (Visual Basic .NET)	WindowsApplication1.zip
Silverlight	SilverlightApplication1.zip, crossdomain.zip
Flash	FlexProject1.zip, crossdomain.zip
Android	AndroidProject1.zip
iOS	iOSDeviceProject1.zip
Windows CE	SmartDeviceProject1.zip
Windows Store Apps	App1.zip

Operating Environment

The system configuration diagram for the sample programs is as below.

 The figure below also describes an example of IP address settings as network settings.

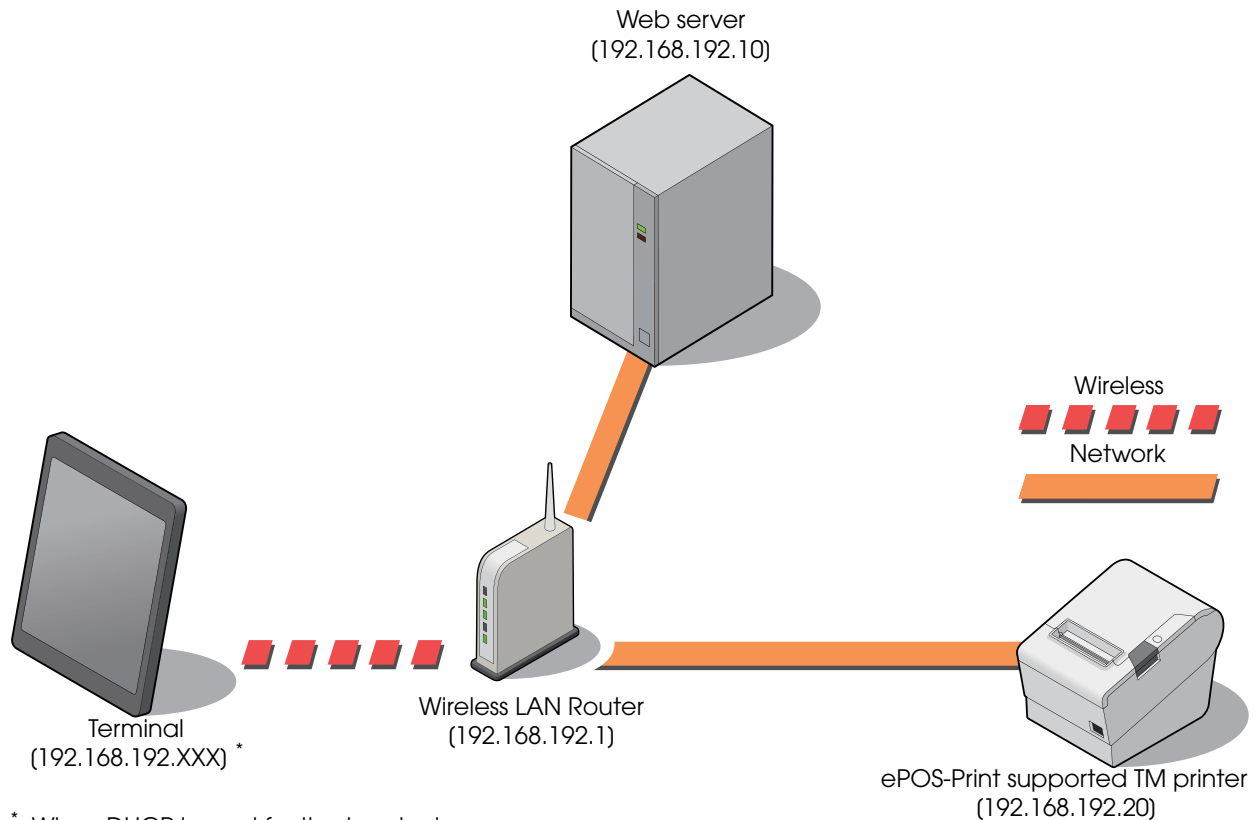

*: When DHCP is used for the terminal

- Web server
(Used for HTML5, Silverlight, and Flash sample programs.)
- Wireless LAN Router
- ePOS-Print supported TM printer (1 set)
- Terminal with an HTML5-supported Web browser

Environment Settings

A flow for configuring the environment settings for the sample program is shown as follows:

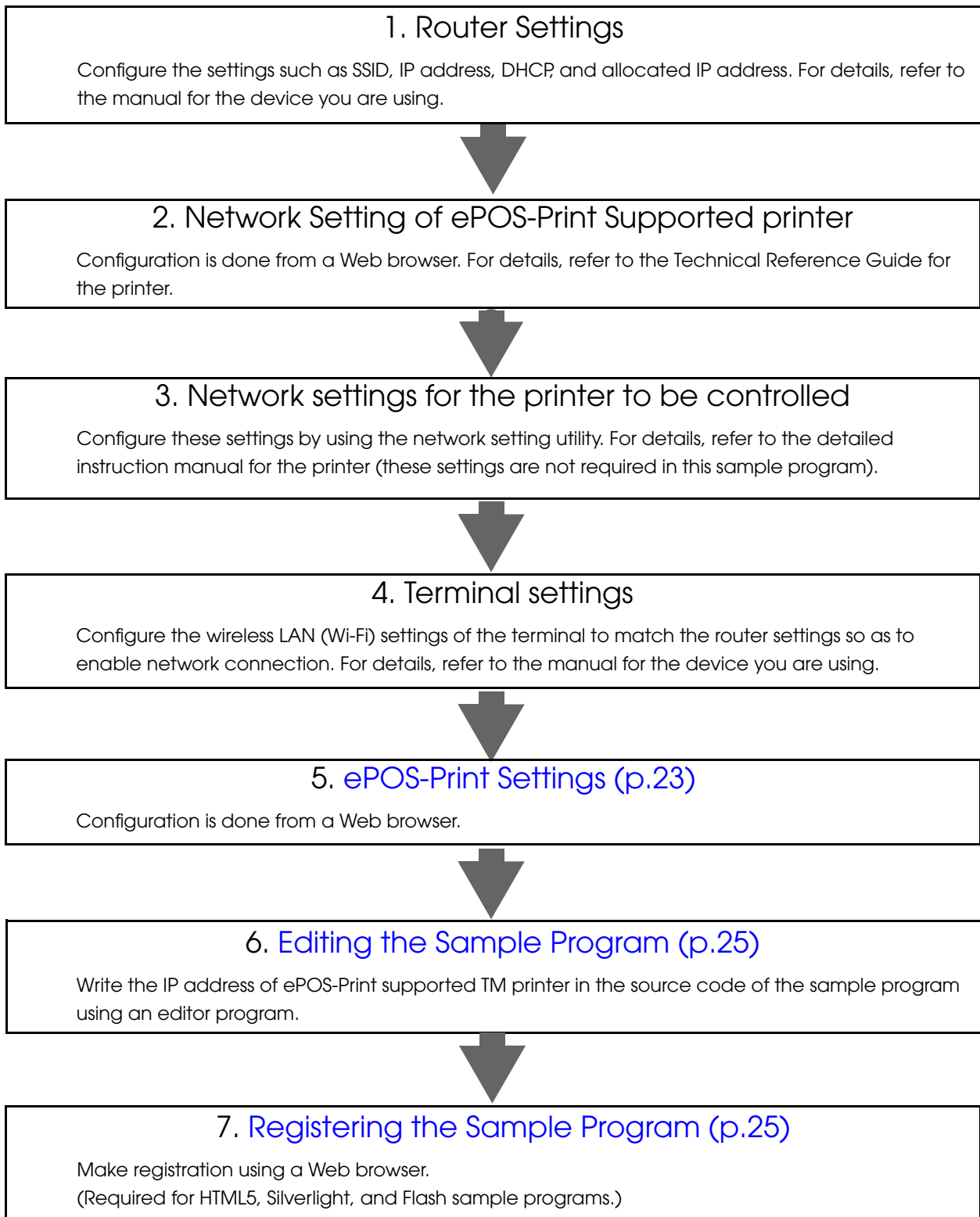

ePOS-Print Settings

- ❑ TM-DT Series
For details, refer to the Technical Reference Guide for each TM-DT Series printer.
- ❑ TM-i Series
For details, refer to the Technical Reference Guide for each TM-i Series printer.
- ❑ TM Printer (Wireless LAN Model)

TM Printer (Wireless LAN Model)

For a TM printer, enable ePOS-Print and set the device ID.



Configure the settings via the network. USB connection cannot be used for setting.

Configure the settings as follows:

- 1** Connect the TM printer to the network.
- 2** Start the web browser of the setting computer and input the TM printer IP address into the address bar.
EpsonNet Config (web version) is displayed.
- 3** Click (ePOS-Print). The "ePOS-Print" screen is displayed.
Configure the following settings.
 - For wireless LAN interface (UB-R04)

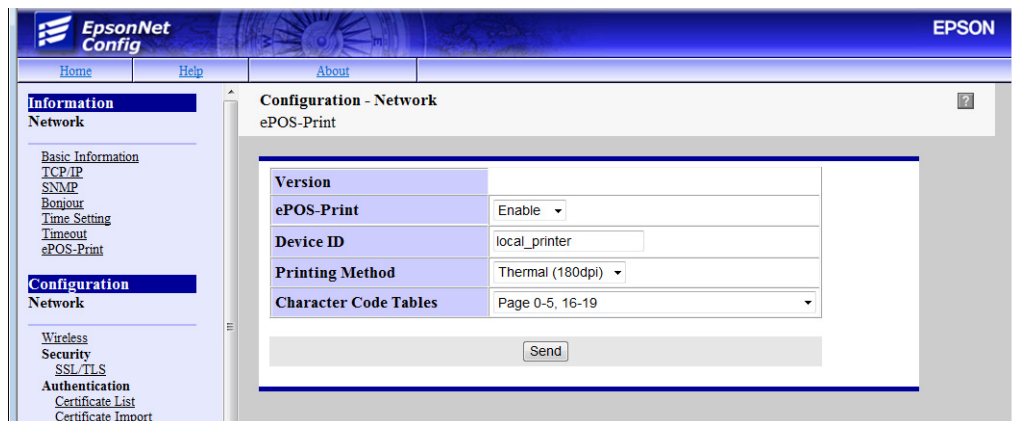

Item	Setting
ePOS-Print	Set to Enable. (Default: Disabled)
Device ID	Align with the system settings. (Default: local_printer)
Printing Method	Set in line with the connected TM printer. (For details, see "Support Information by Printer" (p.106)).
Character Code Table	Align with the connected TM printer and set the TM printer's code page. (For details, see "Support Information by Printer" (p.106) "ePOS-Print Settings").

- For mobile printer (Wireless LAN Model)

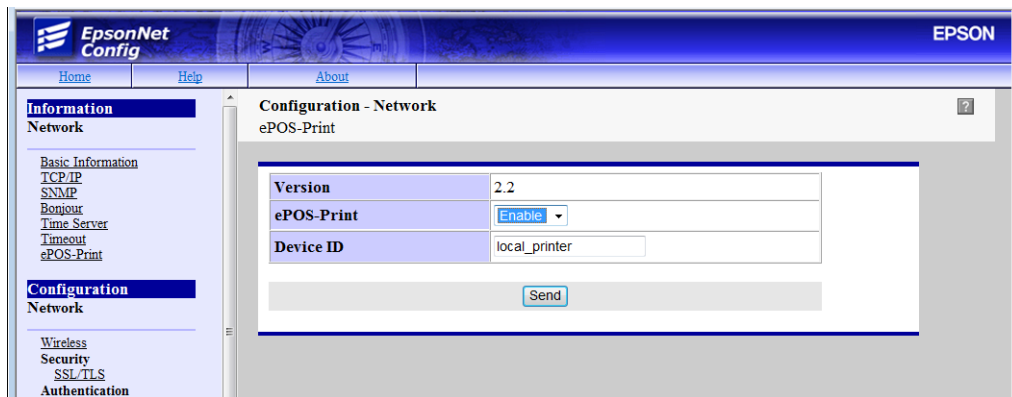

Item	Setting
ePOS-Print	Set to Enable. (Default: Disabled)
Device ID	Align with the system settings. (Default: local_printer)

- 4 Click (Send).
- 5 Turn the TM printer's power off and on again.

Editing the Sample Program

Write the IP address of ePOS-Print supported TM printer in the sample program. Edit the program as follows:

- 1 Expand HtmlApplication1.zip.
- 2 Open index.html using an editor program.
- 3 Change the source code portion "// URL of ePOS-Print supported TM printer" in the source file to the IP address of ePOS-Print supported TM printer and the save the source file.

```
// URL of ePOS-Print supported TM printer
var address = 'http://192.168.192.168/cgi-bin/epos/
                service.cgi?devid=local_printer&timeout=10000'
```

Registering the Sample Program

Register the sample program into the Web server.



- To use TM-DT as the Web server, refer to Technical Reference Guide for each TM-DT.
- To use TM-i as the Web server, refer to Technical Reference Guide for each TM-i.

Register as follows:

- 1 Start the Web server.
- 2 Copy the sample program into the following folder:
Example: Web server configured by using IIS
System drive:\ Inetpub\wwwroot



Copy the sample program as a user with administrator authority.

Environment Settings in Other Execution Environments

This section describes the setting operation in a development environment up to sample program execution.

- ❑ HTML5 (To Build a Web Server on Windows/Linux) (p. 26)
- ❑ Java (p. 27)
- ❑ Windows (Visual Basic .NET) (p. 28)
- ❑ Silverlight (p. 29)
- ❑ Flash (p. 30)
- ❑ Android (p. 31)
- ❑ Windows CE (p. 33)
- ❑ iOS (p. 37)
- ❑ Windows Store Apps (p. 38)

HTML5 (To Build a Web Server on Windows/Linux)

Item	Description
Development environment (example)	Microsoft Visual Studio 2010
Required item	IIS (Internet Information Services) or Apache
Sample program file name	HtmlApplication1.zip
Source editing	Edit the IP address of ePOS-Print supported TM printer to suit the network environment. <Default value> <ul style="list-style-type: none">• TM-DT:<ul style="list-style-type: none">* Wireless LAN: Automatically acquired by DHCP (192.168.192.168 if it cannot be automatically acquired)* Wired LAN: 192.168.192.168• TM-i: Automatically acquired by DHCP (192.168.192.168 if it cannot be automatically acquired)• TM Printer: 192.168.192.168

Environment Setting Procedure

- 1** Install IIS.
- 2** Configure your computer and ePOS-Print supported TM printer so that they can connect to the network.
- 3** Extract the sample program and copy the extracted sample program files into the root folder of IIS.
System drive : `\inetpub\wwwroot`
- 4** Open the sample program html file using Visual Studio.

Java

Item	Description
Development environment (example)	Eclipse
Required item	Java SE Development Kit 6
Sample program file name	JavaProject1.zip
Source editing	<p>Edit the IP address of ePOS-Print supported TM printer to suit the network environment.</p> <p><Default value></p> <ul style="list-style-type: none"> • TM-DT: <ul style="list-style-type: none"> * Wireless LAN: Automatically acquired by DHCP (192.168.192.168 if it cannot be automatically acquired) * Wired LAN: 192.168.192.168 • TM-i: Automatically acquired by DHCP (192.168.192.168 if it cannot be automatically acquired) • TM Printer: 192.168.192.168

Environment Setting Procedure

- 1** Obtain Java SE 6 and install that program.
- 2** Configure your computer and ePOS-Print supported TM printer so that they can connect to the network.
- 3** Uncompress the sample program into any folder.
- 4** Import the sample program using Eclipse.

Windows (Visual Basic .NET)

Item	Description
Development environment (example)	Microsoft Visual Studio 2010
Required item	-
Sample program file name	WindowsApplication1.zip
Source editing	<p>Edit the IP address of ePOS-Print supported TM printer to suit the network environment.</p> <p><Default value></p> <ul style="list-style-type: none">• TM-DT:<ul style="list-style-type: none">* Wireless LAN: Automatically acquired by DHCP (192.168.192.168 if it cannot be automatically acquired)* Wired LAN: 192.168.192.168• TM-i: Automatically acquired by DHCP (192.168.192.168 if it cannot be automatically acquired)• TM Printer: 192.168.192.168

Environment Setting Procedure

- 1** Configure your computer and ePOS-Print supported TM printer so that they can connect to the network.
- 2** Uncompress the sample program into any folder.
- 3** Open the sample program solution file using Visual Studio.

Silverlight

Item	Description
Development environment (example)	Microsoft Visual Studio 2010
Required item	Microsoft Silverlight 4 Tools for Visual Studio 2010
Sample program file name	SilverlightApplication1.zip, crossdomain.zip
Source editing	<p>Edit the IP address of ePOS-Print supported TM printer to suit the network environment.</p> <p><Default value></p> <ul style="list-style-type: none"> • TM-DT: <ul style="list-style-type: none"> * Wireless LAN: Automatically acquired by DHCP (192.168.192.168 if it cannot be automatically acquired) * Wired LAN: 192.168.192.168 • TM-i: Automatically acquired by DHCP (192.168.192.168 if it cannot be automatically acquired) • TM Printer: 192.168.192.168

Environment Setting Procedure



When using by registering the Web server of TM intelligent printer, it is necessary to register cross domain policy file (crossdomain.zip). For detail information on registration method, refer to Technical Reference Guide for each printer.

- 1** Download Microsoft Silverlight 4 Tools for Visual Studio 2010(Silverlight4_Tools.exe) and install that program.
- 2** Configure your computer and ePOS-Print supported TM printer so that they can connect to the network.
- 3** Uncompress the sample program into any folder.
- 4** Open the sample program solution file using Visual Studio.

Flash

Item	Description
Development environment	Flash Builder 4.5 or later
Required item	Flash Builder 4.5 or later
Sample program file name	FlexProject1.zip, crossdomain.zip
Source editing	<p>Edit the IP address of ePOS-Print supported TM printer to suit the network environment.</p> <p><Default value></p> <ul style="list-style-type: none"> • TM-DT: <ul style="list-style-type: none"> * Wireless LAN: Automatically acquired by DHCP (192.168.192.168 if it cannot be automatically acquired) * Wired LAN: 192.168.192.168 • TM-i: Automatically acquired by DHCP (192.168.192.168 if it cannot be automatically acquired) • TM Printer: 192.168.192.168

Environment Setting Procedure



When using by registering the Web server of TM intelligent printer, it is necessary to register cross domain policy file (crossdomain.zip). For detail information on registration method, refer to Technical Reference Guide for each printer.

- 1** Download Adobe Flash Builder from Flash Platform.
- 2** Configure your computer and ePOS-Print supported TM printer so that they can connect to the network.
- 3** Uncompress the sample program into any folder.
- 4** Start Adobe Flash Builder and read the sample program project.

Android

Item	Description
Development environment	Eclipse
Required item	<ul style="list-style-type: none"> • Android SDK 1.5 • Java SE Development Kit 6 • ADT (Android Development Tools) Plug-in for Eclipse
Sample program file name	AndroidProject1.zip
Source editing	<p>Edit the IP address of ePOS-Print supported TM printer to suit the network environment.</p> <p><Default value></p> <ul style="list-style-type: none"> • TM-DT: <ul style="list-style-type: none"> * Wireless LAN: Automatically acquired by DHCP (192.168.192.168 if it cannot be automatically acquired) * Wired LAN: 192.168.192.168 • TM-i: Automatically acquired by DHCP (192.168.192.168 if it cannot be automatically acquired) • TM Printer: 192.168.192.168

Environment Setting Procedure

- 1** Obtain Android SDK and expand it into any folder.
- 2** Download Java SE Development Kit 6 and install that program.
- 3** Start Android SDK Manager and install the Android 1.5(API3) package.
- 4** Start Android AVD Manager and create (Android Virtual Device).
[See "Creating Android Virtual Device" on page 32.](#)
- 5** Install ADT Plug-in in Eclipse.
[See "Installing ADT Plug-in" on page 32](#)
- 6** Change the settings of Eclipse.
[See "Changing the settings of Eclipse" on page 32](#)
- 7** Configure your computer and ePOS-Print supported TM printer so that they can connect to the network.
- 8** Uncompress the sample program into any folder.
- 9** Import the sample program using Eclipse.

Creating Android Virtual Device

- 1** Start Eclipse.
- 2** Select as (Windows)-(Android SDK and AVD Manager).
- 3** The "Android SDK and AVD Manager" screen appears. Select the (New) button.
- 4** On (Create new Android Virtual Device), type the name. Alternatively, select the device to use and create a new entry.

Installing ADT Plug-in

- 1** Start Eclipse.
- 2** From the menu items, select as (Help)-(Install New Software).
- 3** The "Install" screen appears. Click the (Add) button.
- 4** Enter values in the (Name) and (Location) fields and click the (OK) button.

Item	Description
Name	Enter any name.
Location	Enter (https://dl-ssl.google.com/android/eclipse/).

- 5** Return to the "Install" screen. Tick (Developer Tools) and click the (Next) button.
- 6** When the installation process finishes, restart Eclipse.

Changing the settings of Eclipse

- 1** Start Eclipse.
- 2** Select as (Windows)-(Configuration).
- 3** The "Setting" screen appears. Select (Android).
Although a warning dialog box appears, telling you that a path to Android SDK has not been set, there is no problem.
- 4** Click the (Browse) button.
- 5** Select the (Android - Android SDK) directory and click the (OK) button.

Windows CE

Item	Description
Development environment	Microsoft Visual Studio 2008 SP1
Required item	<ul style="list-style-type: none"> Windows Embedded Compact 7 Virtual PC 2007
Sample program file name	SmartDeviceProject1.zip
Source editing	<p>Edit the IP address of ePOS-Print supported TM printer to suit the network environment.</p> <p><Default value></p> <ul style="list-style-type: none"> TM-DT: <ul style="list-style-type: none"> * Wireless LAN: Automatically acquired by DHCP (192.168.192.168 if it cannot be automatically acquired) * Wired LAN: 192.168.192.168 TM-i: Automatically acquired by DHCP (192.168.192.168 if it cannot be automatically acquired) TM Printer: 192.168.192.168

Environment Setting Procedure

- 1** Install Visual Studio 2008 SP1.
- 2** Download Windows Embedded Compact 7 and install that program.
- 3** Install Virtual PC 2007.
- 4** Configure your computer and ePOS-Print supported TM printer so that they can connect to the network.
- 5** Uncompress the sample program into any folder.
- 6** Open the sample program solution file using Visual Studio.
- 7** Execute the sample program using Visual Studio.

- 8 The Device Emulator starts. In the Device Emulator, select as (File)-(Configure...)-(Network).



- 9 The "Emulator Properties" dialog box appears. Select (Network). Tick "Enable NE2000 PCMCIA network adapter and bind to:" and select the computer's network card. Click the (OK) button.

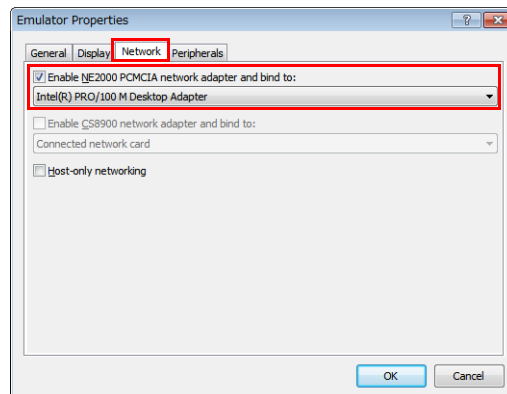

10 In the Device Emulator, select as (Start)-(Settings).

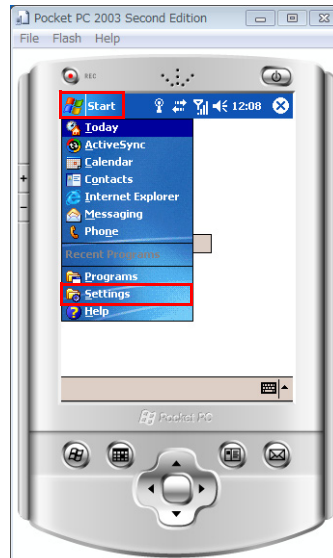

11 In the Device Emulator, select as (Settings)-(Connections)-(Network Cards).

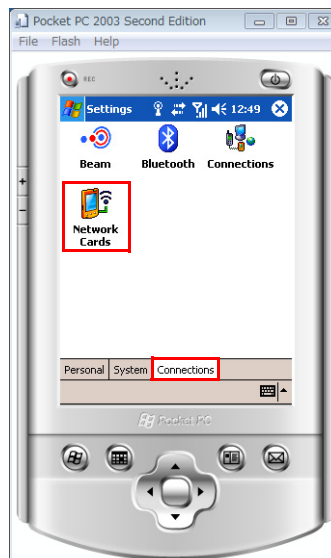

- 12** In the Device Emulator, select (The Internet) and then select the same network card as that of your computer.

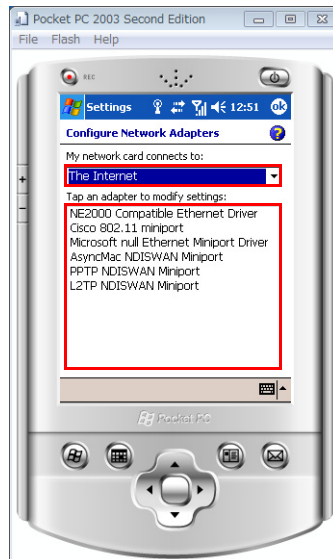

- 13** Set the IP address and click (OK) at the top right of the screen.



- 14** A confirmation dialog box appears. Click (Yes).

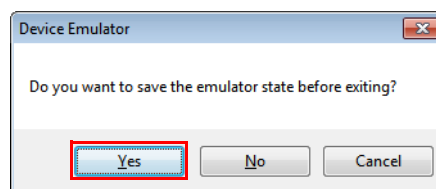

- 15** Restart the Device Emulator.

iOS

Item	Description
OS	Mac OS X 10.6.8
Development environment	Apple Xcode 3.2.6
SDK	iOS SDK 4.3
Sample program file name	iOSDeviceProject1.zip
Source editing	<p>Edit the IP address of ePOS-Print supported TM printer to suit the network environment.</p> <p><Default value></p> <ul style="list-style-type: none"> • TM-DT: <ul style="list-style-type: none"> * Wireless LAN: Automatically acquired by DHCP (192.168.192.168 if it cannot be automatically acquired) * Wired LAN: 192.168.192.168 • TM-i: Automatically acquired by DHCP (192.168.192.168 if it cannot be automatically acquired) • TM Printer: 192.168.192.168
Execution	The sample program can be checked using iOS Simulator.

Environment Setting Procedure

- 1** Expand iOSDeviceProject1.zip.
- 2** Start XCode and open the (iOSDeviceProject1.xcodeproj) project file.
- 3** When the project is opened, the project settings and source files will be displayed.
- 4** From the options displayed when (Set Active Executable) is selected, select an iPhone or iPad file.

Windows Store Apps

Item	Description
OS	Microsoft Visual Studio 2012
Required item	Windows 8
Sample program file name	App1.zip
Source editing	<p>Edit the IP address of ePOS-Print supported TM printer to suit the network environment.</p> <p><Default value></p> <ul style="list-style-type: none">• TM-DT:<ul style="list-style-type: none">* Wireless LAN: Automatically acquired by DHCP (192.168.192.168 if it cannot be automatically acquired)* Wired LAN: 192.168.192.168• TM-i: Automatically acquired by DHCP (192.168.192.168 if it cannot be automatically acquired)• TM Printer: 192.168.192.168

Environment Setting Procedure

- 1** Configure your computer and ePOS-Print supported TM printer so that they can connect to the network.
- 2** Uncompress the sample program into any folder.
- 3** Open the sample program solution file using Visual Studio.

Programming Guide (XML Print Service)

This chapter describes how to write programs in the application development using ePOS-Print.

How to Use XML Schemas

The XML document editing support function in the integrated development environment helps efficiently create XML documents and validate XML documents.



This section describes specific procedures using Visual Studio (p. 39) and Eclipse (p. 42) as examples.

Visual Studio

Setting Procedure

- 1 Create a new project.
(File)-(New)-(Project...)

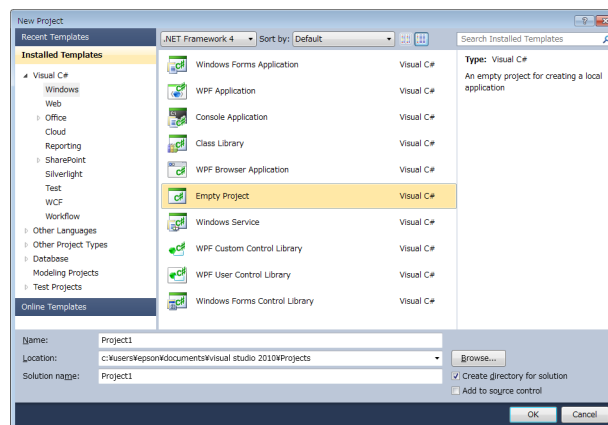

- 2 Add an XML file to the created project.
(Project)-(Add New Item...)

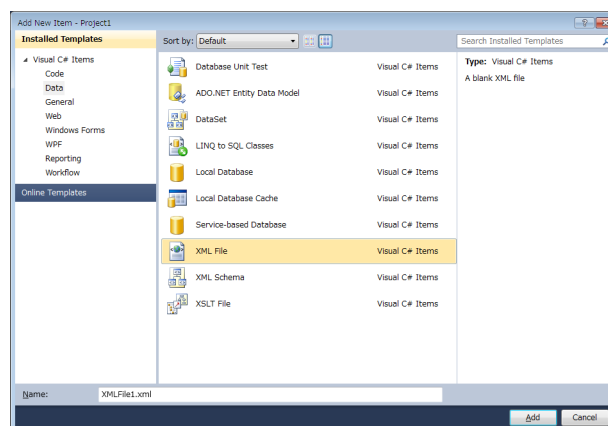

- 3 Set the XML schema "epos-print-4.x.x.xsd" to the XML file. (XML)-(Schemas...)-(Add...)

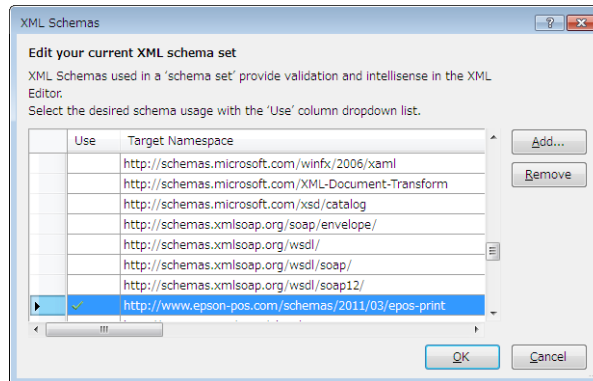

Editing Example



For details on elements, refer to [XML Reference \(p.61\)](#).

- 1 Enter the character "<" in the XML file. Then, root element candidates appear.

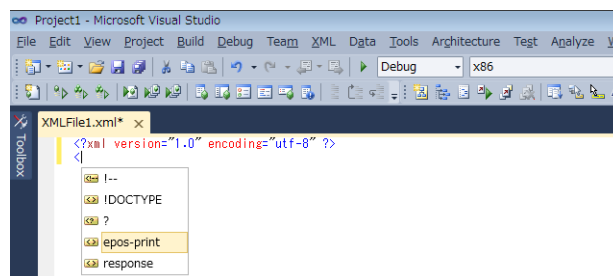

- 2 Select "epos-print" from the candidates and enter the character ">". Then, the epos-print root element is added.

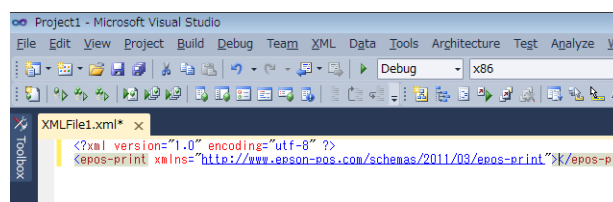

- 3 Start a new line and enter the character "<". Then, element candidates appear.

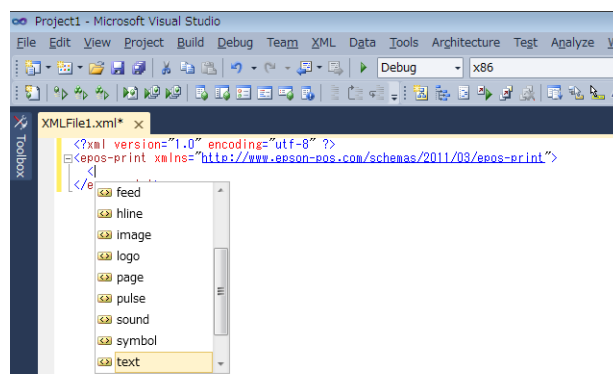

- 4 Select "text" from the candidates and enter an empty space. Then, attribute candidates appear.

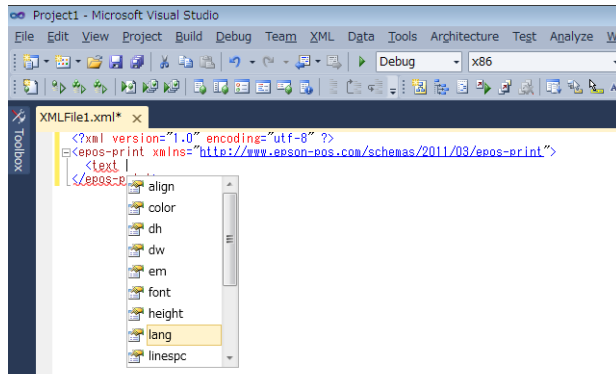

- 5 Select "lang" from the candidates. Then, attribute value candidates appear.

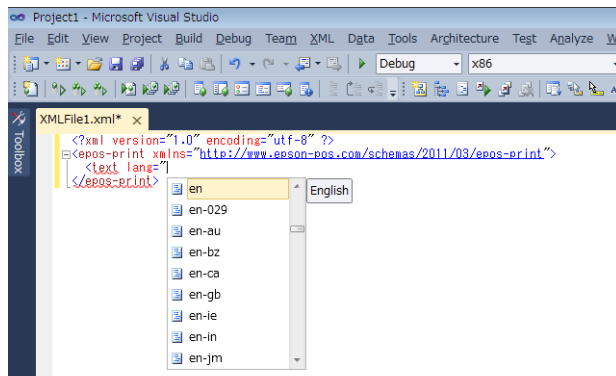

- 6 Select "en" from the candidates and enter the character ">". Then, the text element is added.

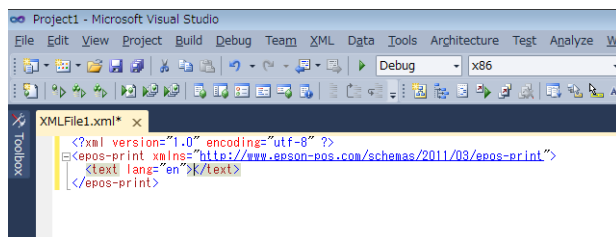

- 7 Enter a character string to print for the content of the text element.

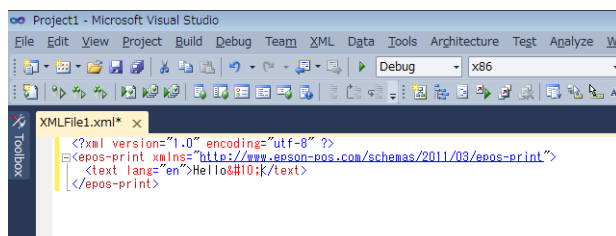

Eclipse

Setting Procedure

Create an XML file and set the location of the schema using URL as follows:

```
<?xml version="1.0" encoding="UTF-8"?>
<epos-print xmlns:xsi="http://www.w3.org/2001/XMLSchema-instance"
xsi:schemaLocation="http://www.epson-pos.com/schemas/2011/03/epos-print
epos-print-4.x.x.xsd"
xmlns="http://www.epson-pos.com/schemas/2011/03/epos-print">

<text lang='en'>Hello&#10;</text>

</epos-print>
```



For details on elements, refer to [XML Reference \(p.61\)](#).

ePOS-Print XML



In this chapter, descriptions are made mainly based on a HTML5 environment. For an environment other than the above, read such descriptions in ways that suit the relevant environment.

Print Mode

There are two types of print modes: standard and page modes.

Standard mode

In standard mode, characters are printed line by line. The line feed space is adjusted based on the font size and the height of images, barcodes, etc. This mode is suitable for the type of printing such as printing receipts that requires the paper length to change according to the print space.

Page mode

In page mode, you set a print area, lay out data in it, and print the data in a batch operation. Characters, images, and barcodes are laid out in the print positions (coordinates).

Programming Flow

For the ePOS-Print XML, programming is performed based on the following work flow:

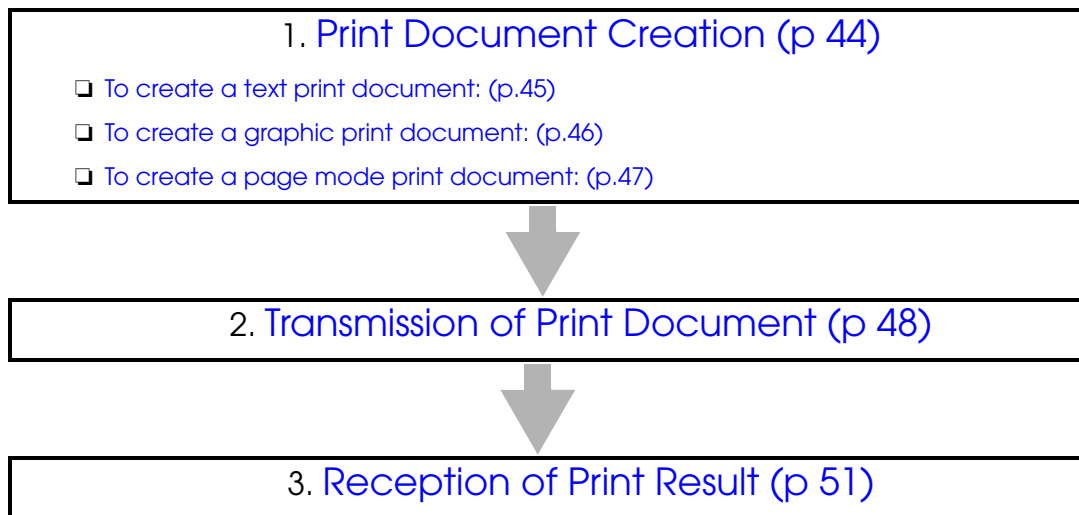

To ensure successful print operation, write a program in such a way that data is sent after checking the printer status. For the above procedure, refer to [Checking the Printer Status \(p.53\)](#).

Print Document Creation

Create a print document using elements in the epos-print root element. For details on elements, refer to [Element List \(p.61\)](#).

Refer to the following program for print document creation.

```
<!DOCTYPE html>
<html>
<head>
<meta charset="utf-8" />
<title>TITLE</title>
<script type="text/javascript">
  function createDocument() {
    //Start print document creation.
    var request = '<epos-print xmlns="http://www.epson-pos.com/schemas/2011/03/epos-print">';
    //Create a print document
    request += '<text lang="en" smooth="true"/>';
    request += '<text font="font_a"/>';
    request += '<text width="3" height="3">Hello, World!&#10;</text>';
    request += '<cut type="feed"/>';
    //End print document creation.
    request += '</epos-print>';
  }
</script>
</head>
<body>
</body>
</html>
```

Create a print document

To create a text print document:

Create a text print document using the text element in the epos-print root element. Configure the settings for the text to print using the attributes of the text element.

Refer to the following program for print document creation.

For the string "Hello World!", to create a print document based on the following settings:

- Font: FontA
- Scale: x 4 (horizontal) and x 4 (vertical)
- Style: Bold

```
<script type="text/javascript">
  function createDocument() {
    //Start print document creation.
    var request = '<epos-print xmlns="http://www.epson-pos.com/schemas/2011/03/
epos-print">';
    //Create a print document
    //<Configure the print character settings>
    request += '<text lang="en"/>';
    request += '<text smooth="true"/>';
    request += '<text font="font_a"/>';
    request += '<text width="4" height="4"/>';
    request += '<text em="true"/>';
    //<Specify the character string to print>
    request += '<text>Hello, World!&#10;</text>';
    //<Specify the feed cut>
    request += '<cut type="feed"/>';
    //End print document creation.
    request += '</epos-print>';
  }
</script>
```

Print image



Hello, World!

To create a graphic print document:

Create a graphic print document using the image element in the epos-print root element. Set the image size using an attribute of the image element. For graphics, specify raster graphic bit-image data using a base 64 encoded character string.

Refer to the following program for print document creation.

To create a print document with a checkered flag raster image:

```
<script type="text/javascript">
  function createDocument() {
    //Start print document creation.
    var request = '<epos-print xmlns="http://www.epson-pos.com/schemas/2011/03/epos-print">';
    //Create a print document
    //<Specify the raster image>
    request += '<image width="8" height="48">8PDw8A8PDw/w8PDwDw8PD/Dw8PAPDw8P8PDw8A8PDw/w8PDwDw8PD/Dw8PAPDw8P</image>';
    //<Specify the feed cut>
    request += '<cut type="feed"/>';
    //End print document creation.
    request += '</epos-print>';
  }
</script>
```



- This section describes how to print a raster image. In addition, there is also a method of printing graphics registered in the NV memory of the printer. For details, refer to [<logo> \(p.76\)](#).
- For details on how to create raster images, refer to [Encoding Graphic Data \(p.145\)](#).

Print image



To create a page mode print document:

Create a graphic print document using the image element in the epos-print root element. Set the image size using an attribute of the image element. For graphics, specify raster graphic bit-image data using a base 64 encoded character string.

Refer to the following program for print document creation.

For the string "Hello World!", to create a print document based on the following settings:

- Page mode print area (in dots)
 - Origin of horizontal axis: 100, origin of vertical axis: 50, width: 200, height: 100
- Page mode print positions (in dots)
 - Horizontal print position: 0, vertical print position: 42
- Font: FontA
- Scale: x 2 (horizontal) and x 2 (vertical)
- Style: Bold

```
<script type="text/javascript">
  function createDocument() {
    //Start print document creation.
    var request = '<epos-print xmlns="http://www.epson-pos.com/schemas/2011/03/epos-print">';
    //Create a print document
    //<The page mode starts>
    request += '<page>';
    //<Specify the page mode print area>
    request += '<area x="100" y="50" width="200" height="100"/>';
    //<Specify the page mode print position>
    request += '<position x="0" y="42"/>';
    //<Set print text>
    request += '<text lang="en"/>';
    request += '<text smooth="true"/>';
    request += '<text font="font_a"/>';
    request += '<text width="2" height="2"/>';
    request += '<text em="true"/>';
    //<Specify the character string to print>
    request += '<text>Hello,</text>';
    request += '<position x="0" y="96"/>';
    request += '<text>World!</text>';
    //<The page mode ends>
    request += '</page>';
    //<Specify the feed cut>
    request += '<cut type="feed"/>';
    //End print document creation.
    request += '</epos-print>';
  }
</script>
```

Print image

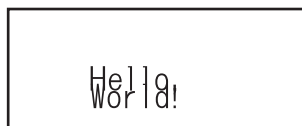

Transmission of Print Document

A print document is sent using an ePOS-Print object.

Create an ePOS-Print object using the constructor and specify the end point address for the printer to be used for printing as well as the print document into the send method to send the document.

For the details about the printer end point address, refer to [Printer End Point Address \(p.50\)](#).

Refer to the following program.



ePOS-Print supported TM printer checks the status of the TM printer used for printing and then start printing operation.

To Call SOAP/HTTP Interface

Refer to the following program.

```
<!DOCTYPE html>
<html>
<head>
<meta charset="utf-8" />
<title>TITLE</title>
<script type="text/javascript">
  function sendDocument() {
    //Create a print document
    var request = '<epos-print xmlns="http://www.epson-pos.com/schemas/2011/03/epos-print">';
    request += '<text lang="en" smooth="true"/>';
    request += '<text font="font_a"/>';
    request += '<text width="3" height="3">Hello, World!&#10;</text>';
    request += '<cut type="feed"/>';
    request += '</epos-print>';

    //Create a SOAP envelop
    var soap = '<s:Envelope xmlns:s="http://schemas.xmlsoap.org/soap/envelope/">' +
      '<s:Body>' + request + '</s:Body></s:Envelope>';

    //Create an XMLHttpRequest object
    var xhr = new XMLHttpRequest();
    //Set the end point address
    var url = 'http://192.168.192.168/cgi-bin/epos/
      service.cgi?devid=local_printer&timeout=10000';
    //Open an XMLHttpRequest object
    xhr.open('POST', url, true);
    //<Header settings>
    xhr.setRequestHeader('Content-Type', 'text/xml; charset=utf-8');
    xhr.setRequestHeader('If-Modified-Since', 'Thu, 01 Jan 1970 00:00:00 GMT');
    xhr.setRequestHeader('SOAPAction', '');

    // Send print document
    xhr.send(soap);
  }
</script>
</head>
<body>
</body>
</html>
```

Send print document

To Call SOAP/HTTP Interface (WSDL supported)

Refer to the following program.

```

<!DOCTYPE html>
<html>
<head>
<meta charset="utf-8" />
<title>TITLE</title>
<script type="text/javascript">
  function sendDocument() {
    //Create a print document
    var request = '<epos-print xmlns="http://www.epson-pos.com/schemas/2011/03/epos-print">';
    request += '<text lang="en" smooth="true"/>';
    request += '<text font="font_a"/>';
    request += '<text width="3" height="3">Hello, World!&#10;</text>';
    request += '<cut type="feed"/>';
    request += '</epos-print>';

    //Create a print parameter
    var param = '<parameter xmlns="http://www.epson-pos.com/schemas/2011/03/epos-print">';
    param += '<devid>local_printer</devid>';
    param += '<timeout>10000</timeout>';
    param += '<printjobid>ABC123</printjobid>';
    param += '</parameter>';

    //Create a SOAP envelop
    var soap = '<s:Envelope xmlns:s="http://schemas.xmlsoap.org/soap/envelope/">' +
      '<s:Header>' + param + '</s:Header><s:Body>' + request +
      '</s:Body></s:Envelope>';

    //Create an XMLHttpRequest object
    var xhr = new XMLHttpRequest();
    //Set the end point address
    var url = 'http://192.168.192.168/cgi-bin/epos/service.cgi';
    //Open an XMLHttpRequest object
    xhr.open('POST', url, true);
    //<Header settings>
    xhr.setRequestHeader('Content-Type', 'text/xml; charset=utf-8');
    xhr.setRequestHeader('If-Modified-Since', 'Thu, 01 Jan 1970 00:00:00 GMT');
    xhr.setRequestHeader('SOAPAction', '');

    // Send print document
    xhr.send(soap);
  }
</script>
</head>
<body>
</body>
</html>

```

Send print document

Printer End Point Address

Specify the printer end point address in the following format:

To Call [SOAP/HTTP Interface \(p. 10\)](#)

http://(IP address)/cgi-bin/epos/service.cgi?devid=(device ID)&timeout=(timeout time)

To Call [SOAP/HTTP Interface \(WSDL supported\) \(p. 10\)](#)

http://(IP address)/cgi-bin/epos/service.cgi

Items to specify	Description
IP address	Specify either the IP address or the domain name of ePOS-Print supported TM printer.
Device ID	Specifies the printer to be used for printing. The maximum value is 60 seconds (60000). Specify the Device ID registered using the EPSON TMNet WebConfig(EpsonNet Config) of ePOS-Print supported TM printer
Timeout period	Specifies the time to abort the process in milliseconds. The maximum value is 300 seconds (300000). The timeout parameter is optional; when it is omitted, 60 seconds (60000) is set. When the timeout period elapses, the print job is canceled; the data already interpreted by the printer before the start of the print abort process is printed.



For SOAP/HTTP Interface (WSDL supported), the device ID and timeout time are specified in the SOAP header.

Reception of Print Result

Set a callback function using the response root element (p. 63) to receive print results.

The following information is obtained:

- Print result
- Error code
- Printer status
- Printer's battery status



The printer status can be obtained when communication with the printer is possible.

Refer to the following program. For the details about how to program a callback function in detail, refer to [Error handling \(p.52\)](#).

```

<!DOCTYPE html>
<html>
<head>
<meta charset="utf-8" />
<title>TITLE</title>
<script type="text/javascript">
  function sendDocument() {
    //Create a print document
    var request = '<epos-print xmlns="http://www.epson-pos.com/schemas/2011/03/epos-print">';
    request += '<text lang="en" smooth="true"/>';
    request += '<text font="font_a"/>';
    request += '<text width="3" height="3">Hello, World!&#10;</text>';
    request += '<cut type="feed"/>';
    request += '</epos-print>';

    //Create a SOAP envelop
    var soap = '<?xml version="1.0" encoding="utf-8"?>' +
      '<s:Envelope xmlns:s="http://schemas.xmlsoap.org/soap/envelope/">' +
      '<s:Body>' + request + '</s:Body></s:Envelope>';

    //Create an XMLHttpRequest object
    var xhr = new XMLHttpRequest();
    //Set the end point address
    var url = 'http://192.168.192.168/cgi-bin/epos/
      service.cgi?devid=local_printer&timeout=10000';
    //Open an XMLHttpRequest object
    xhr.open('POST', url, true);
    //<Header settings>
    xhr.setRequestHeader('Content-Type', 'text/xml; charset=utf-8');
    xhr.setRequestHeader('If-Modified-Since', 'Thu, 01 Jan 1970 00:00:00 GMT');
    xhr.setRequestHeader('SOAPAction', '');

    //Set a callback function
    xhr.onreadystatechange = function () {
      if (xhr.readyState == 4) {
        if (xhr.status == 200) {
          //Obtain the response root element
          var res = xhr.responseXML;
          var success = res.getElementsByTagName('response')[0].getAttribute('success');
          //When the printing is not successful, display a message
          if (!/^(1|true)$/.test(success)) {
            alert('A print error occurred');
          }
        }
      }
    }

    // Send print document
    xhr.send(soap);
  }
</script>
</head>
<body>
</body>
</html>

```

Callback function for print result reception

Error handling

Refer to the following program for the error handling method by a callback function.

```
// Set a response receipt callback function
xhr.onreadystatechange = function () {
    :
    :
    // Obtain the print result and error code
    var res = xhr.responseXML;
    var msg = 'Print' + (res[0].getAttribute('success') ? 'Success' : 'Failure') +
        '\nCode:' + res[0].getAttribute('code') +
        '\nStatus:\n';
    // Obtain the printer status
    var asb = res[0].getAttribute('status');
    if (asb & 0x00000001) {
        msg += ' No printer response\n';
    }
    if (asb & 0x00000002) {
        msg += ' Print complete\n';
    }
    if (asb & 0x00000004) {
        msg += ' Status of the drawer kick number 3 connector pin = "H"\n';
    }
    if (asb & 0x00000008) {
        msg += ' Offline status\n';
    }
    if (asb & 0x00000020) {
        msg += ' Cover is open\n';
    }
    if (asb & 0x00000040) {
        msg += ' Paper feed switch is feeding paper\n';
    }
    if (asb & 0x00000100) {
        msg += ' Waiting for online recovery\n';
    }
    if (asb & 0x00000200) {
        msg += ' Panel switch is ON\n';
    }
    if (asb & 0x00000400) {
        msg += ' Mechanical error generated\n';
    }
    if (asb & 0x00000800) {
        msg += ' Auto cutter error generated\n';
    }
    if (asb & 0x00002000) {
        msg += ' Unrecoverable error generated\n';
    }
    if (asb & 0x00004000) {
        msg += ' Auto recovery error generated\n';
    }
    if (asb & 0x00020000) {
        msg += ' No paper in the roll paper near end detector\n';
    }
    if (asb & 0x00080000) {
        msg += ' No paper in the roll paper end detector\n';
    }
    if (asb & 0x80000000) {
        msg += ' Stop the spooler\n';
    }
    //Display in the dialog box
    alert(msg);
}
```

Checking the Printer Status

To check the printer status without printing, send empty print data.
Refer to the following program.

```
//Set the end point address
var url = 'http://192.168.192.168/cgi-bin/epos/service.cgi?devid=local_printer
                                                &timeout=10000';

//Create an empty print document to check the printer status
var soap = '<?xml version="1.0" encoding="UTF-8"?><s:Envelope xmlns:s="http://
            schemas.xmlsoap.org/soap/envelope/" ><s:Body><epos-print xmlns="http://
            www.epson-pos.com/schemas/2011/03/epos-print"/></s:Body></s:Envelope>';

//Create an XMLHttpRequest object
var xhr = new XMLHttpRequest();
//<Open an XMLHttpRequest object>
xhr.open('POST', url, true);
//<Header settings>
xhr.setRequestHeader('Content-Type', 'text/xml; charset=utf-8');
xhr.setRequestHeader('If-Modified-Since', 'Thu, 01 Jan 1970 00:00:00 GMT');
xhr.setRequestHeader('SOAPAction', '');

//Set a response reception callback function for checking
xhr.onreadystatechange = function () {
    if (xhr.readyState == 4){
        if (xhr.status == 200){
            var res = xhr.responseXML;
            var success = res.getElementsByTagName('response')[0].getAttribute('success');
            if (!/^(1|true)$/.test(success)) {
                alert('Success');
            }
        }
    }
};

//Send empty print data
xhr.send(soap);
```

Specifying the Print Job ID from the Application

A response containing the specified print job ID will be returned when sending a request from the application by specifying the print job ID. (ePOS-Print Service Ver.4.1 or later versions)

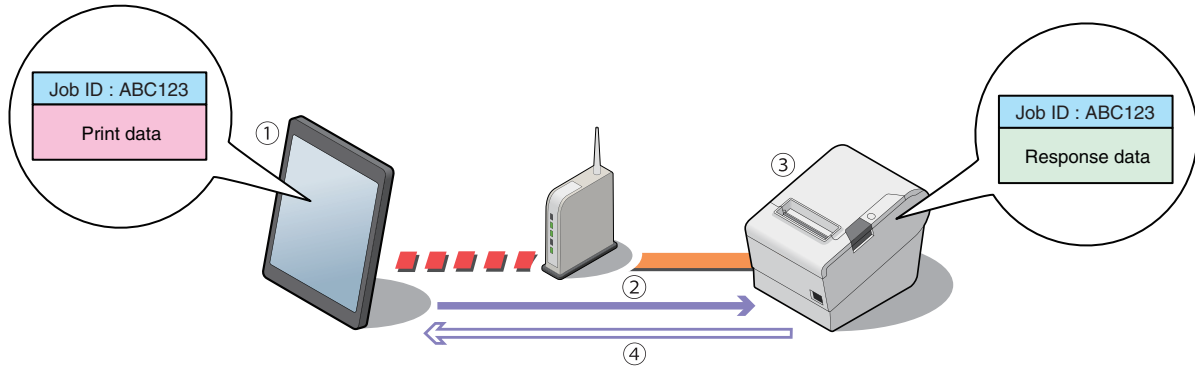

Programming Example

Request

```
<s:Envelope xmlns:s="http://schemas.xmlsoap.org/soap/envelope/">
  <s:Header>
    <parameter xmlns="http://www.epson-pos.com/schemas/2011/03/epos-print">
      <devid>local_printer</devid>
      <timeout>60000</timeout>
      <printjobid>ABC123</printjobid>
    </parameter>
  </s:Header>
  <s:Body>
    <epos-print xmlns="http://www.epson-pos.com/schemas/2011/03/epos-print">
      <text>Hello, World!&#10;</text>
      <cut />
    </epos-print>
  </s:Body>
</s:Envelope>
```

Response

```
<s:Envelope xmlns:s="http://schemas.xmlsoap.org/soap/envelope/">
  <s:Header>
    <parameter xmlns="http://www.epson-pos.com/schemas/2011/03/epos-print">
      <devid>local_printer</devid>
      <timeout>60000</timeout>
      <printjobid>ABC123</printjobid>
    </parameter>
  </s:Header>
  <s:Body>
    <response xmlns="http://www.epson-pos.com/schemas/2011/03/epos-print"
      success="true" code="" status="252641302" battery="0" />
  </s:Body>
</s:Envelope>
```

Using the Spooler Function

The spooler function is available in TM-DT Software Ver.3.0 or later/TM-i Firmware Ver.4.1 or later. A printing job will be executed immediately and a response will be returned to the application after printing is complete when sending a printing request to ePOS-Print Service I/F from the application when the spooler function is disabled.

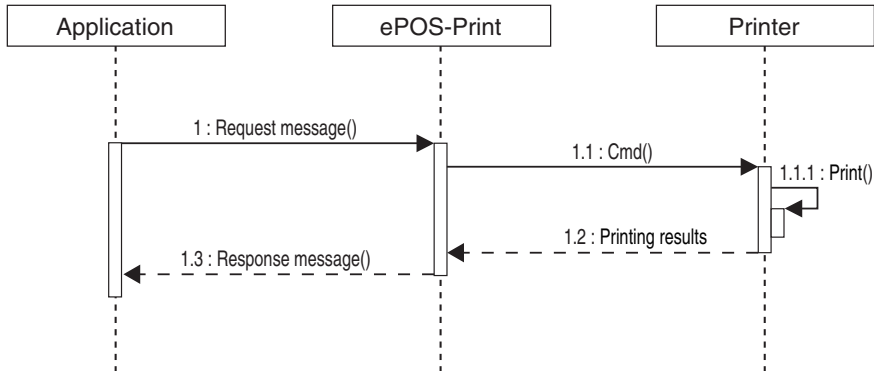

The print data job will be added to the queue and a response will be returned to the application without waiting for printing to complete when sending a printing request to ePOS-Print Service I/F from the application when the spooler function is enabled.

Even if the output printer cannot complete the printing task, ePOS-Print Service I/F does not return an error to the application. If print forwarding is enabled, printing from a substitute printer is available. The application can obtain the print result later by requesting an empty print data with the print job ID specified. Refer to the sequence diagram below.

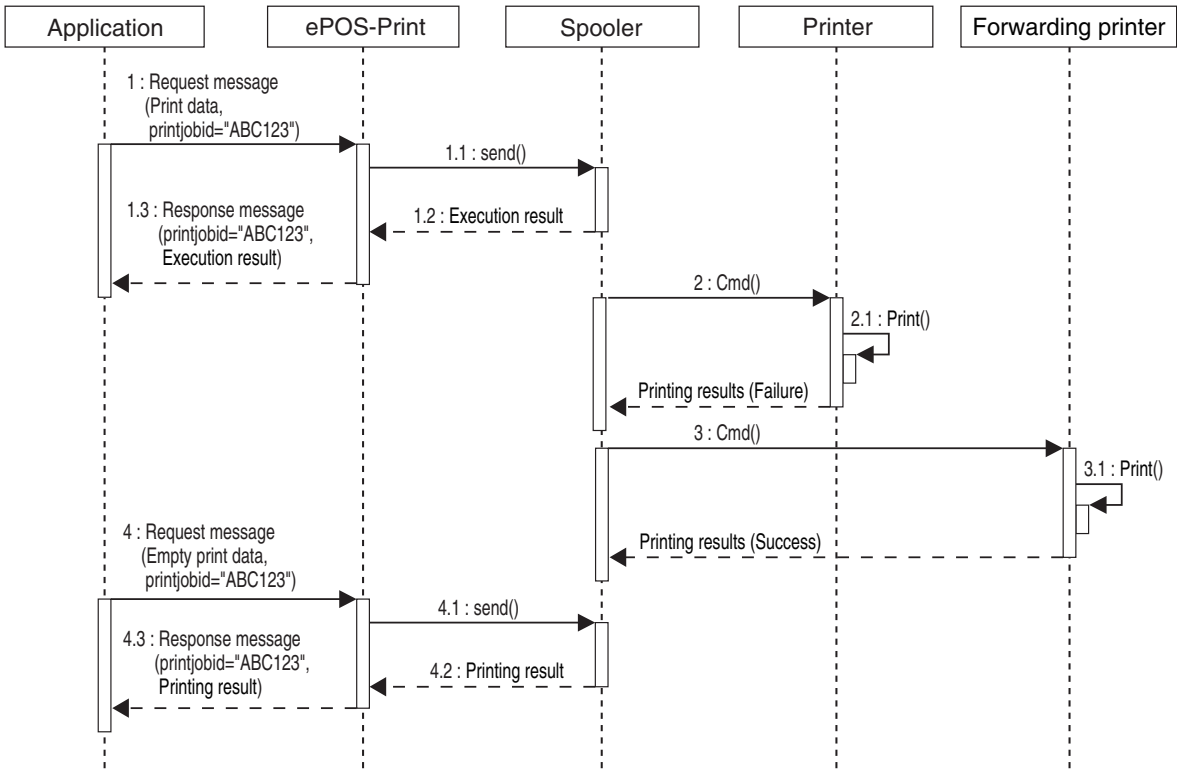

Programming Example

Printing Process

Request

```
<s:Envelope xmlns:s="http://schemas.xmlsoap.org/soap/envelope/">
  <s:Header>
    <parameter xmlns="http://www.epson-pos.com/schemas/2011/03/epos-print">
      <devid>local_printer</devid>
      <timeout>60000</timeout>
      <printjobid>ABC123</printjobid>
    </parameter>
  </s:Header>
  <s:Body>
    <epos-print xmlns="http://www.epson-pos.com/schemas/2011/03/epos-print">
      <text>Hello, World!&#10;</text>
      <cut />
    </epos-print>
  </s:Body>
</s:Envelope>
```

Response

```
<s:Envelope xmlns:s="http://schemas.xmlsoap.org/soap/envelope/">
  <s:Header>
    <parameter xmlns="http://www.epson-pos.com/schemas/2011/03/epos-print">
      <devid>local_printer</devid>
      <printjobid>ABC123</printjobid>
    </parameter>
  </s:Header>
  <s:Body>
    <response xmlns="http://www.epson-pos.com/schemas/2011/03/epos-print"
      success="true" code="" status="2" battery="0" />
  </s:Body>
</s:Envelope>
```



- The TM intelligent printer will issue a print job ID if the print job ID is not specified by the application.
- As the printing process has not been performed at this time, success will be set to "true," code to "" (left empty), status to 0x00000002 or 0x80000000 and battery to "0".

Acquiring the Print Job Status

Request

```
<s:Envelope xmlns:s="http://schemas.xmlsoap.org/soap/envelope/">
  <s:Header>
    <parameter xmlns="http://www.epson-pos.com/schemas/2011/03/epos-print">
      <printjobid>ABC123</printjobid>
    </parameter>
  </s:Header>
  <s:Body>
    <epos-print xmlns="http://www.epson-pos.com/schemas/2011/03/epos-print" />
  </s:Body>
</s:Envelope>
```



Empty print data is sent when requesting the acquisition of the print job status.
As such, child elements of the <epos-print> element are not specified.

Response

```
<s:Envelope xmlns:s="http://schemas.xmlsoap.org/soap/envelope/">
  <s:Header>
    <parameter xmlns="http://www.epson-pos.com/schemas/2011/03/epos-print">
      <printjobid>ABC123</printjobid>
    </parameter>
  </s:Header>
  <s:Body>
    <response xmlns="http://www.epson-pos.com/schemas/2011/03/epos-print"
      success="true" code="" status="252641302" battery="0" />
  </s:Body>
</s:Envelope>
```

Printing in Other Environments

This section describes how to generate client codes (proxy class) from WSDL by using the tool provided in the development environment.



This section uses the following cases as examples:

- [.NET Framework \(p.58\)](#)
- [Java \(p.60\)](#)

.NET Framework

Item	Description
Tool	ServiceModel Metadata Utility Tool (Svcutil.exe)
Command	> svcutil.exe epos-print-4.x.x.wsdl epos-print-4.x.x.xsd



For details about the Svcutil.exe tool, refer to the following Web site (as of October, 2014):
<http://msdn.microsoft.com/en-us/library/aa347733.aspx>

Procedure

- 1** From the command prompt, execute Svcutil.exe and create the following files:
 - ePOSPrint.cs (WCF contract)
 - output.config (application configuration file)
- 2** Start Visual Studio and create a new project.
(Project example: console application)
- 3** Add a class file to the project.
(File to be added: ePOSPrint.cs)
- 4** Add a reference to the project.
(Assembly to be added: System.ServiceModel)
- 5** Edit the application configuration file.
(File to be edited: App.config)
 - Open output.config and copy the <system.serviceModel> element.
 - Change the end point address in accordance with the printer.

6 Create and execute a program to call XML Print Service.

Editing example (File to be edited: Program.cs)

```
namespace ConsoleApplication1
{
    class Program
    {
        static void Main(string[] args)
        {
            ePOSPrintPortTypeClient client = new ePOSPrintPortTypeClient();

            parameter param = new parameter();
            param.printjobid = "ABC123";
            param.devid = "local_printer";
            param.timeout = "60000";

            eposprint epos = new eposprint();
            text t = new text();
            t.align = align.center;
            t.alignSpecified = true;
            t.dh = true;
            t.dhSpecified = true;
            t.Value = "Hello, World!\n";
            cut c = new cut();
            c.type = cuttype.feed;
            epos.Items = new object[] { t, c };

            response res = client.send(ref param, epos);
            Console.WriteLine(res.success);
            Console.WriteLine(res.code);
            Console.WriteLine(res.status);
            Console.WriteLine(res.battery);
            Console.ReadLine();
        }
    }
}
```

Java

Item	Description
Tool	JAX-WS wsimport tool
Command	> wsimport epos-print-4.1.0.wsdl



For details about the JAX-WS wsimport tool, refer to following Web site (as of October, 2014):
<http://docs.oracle.com/javase/8/docs/technotes/tools/unix/wsimport.html>
<http://docs.oracle.com/javase/8/docs/technotes/tools/windows/wsimport.html>

XML Reference

This chapter describes Command Reference for ePOS-Print XML print documents.



For differences in specifications according to printer type, refer to [Support Information by Printer \(p.106\)](#).

Element List

Root element	Element	Function	Standard mode	Page mode	Page
<epos-print>		Request	●	●	p. 62
	<text>	Prints text	●	●	p. 66
	<feed>	Paper feed	●	●	p. 72
	<image>	Prints raster image	●	●	p. 74
	<logo>	Prints NV logo	●	●	p. 76
	<barcode>	Prints barcode	●	●	p. 77
	<symbol>	Prints symbol	●	●	p. 81
	<hline>	Prints horizontal line	●	-	p. 86
	<vline-begin>	Starts vertical line	●	-	p. 87
	<vline-end>	Ends vertical line	●	-	p. 88
	<page>	Page mode	●	-	p. 89
	<area>	Sets a page mode print area	-	●	p. 90
	<direction>	Sets a page mode print direction	-	●	p. 91
	<position>	Sets a page mode print position	-	●	p. 92
	<line>	Draws a page mode line	-	●	p. 93
	<rectangle>	Draws a page mode rectangle	-	●	p. 94
	<cut>	Paper cut	●	-	p. 95
	<pulse>	Drawer kick-out	●	-	p. 96
	<sound>	Sounds a buzzer	●	-	p. 97
	<command>	Inserts a command	●	●	p. 97
<layout> *1	Setting of paper layout	●	-	p. 100	
<recovery> *2	Recovers from an error	●	-	p. 104	
<reset> *2	Resets the printer	●	-	p. 105	
<response>	Response	●	●	p. 63	

● : Available, - : Not available

*1 ePOS-Print Service Ver.2.2 or later versions supported

*2 ePOS-Print Service Ver.2.3 or later versions supported

Root Element

<epos-print>

An XML document to be sent from a host to a printer.

This document requests the printer to execute the specified function and performs initialization when printing starts.

<epos-print> has elements. Refer to Element List (p. 61).

Attribute

- force : (data type xs:boolean)
This is the forced transmission mode. (in ePOS-Print Service Ver.3.0 and later)
If you enable forced transmission mode, print commands are forcibly sent to the printer.

Attribute value	Description
true or 1	Sets forced transmission mode.
false or 0	Sets normal transmission mode.



- Use forced transmission mode when the printer is offline.
It will result in an error if the printer is online.
- The following functions are enabled in forced transmission mode.
 - * Drawer kick-out (<pulse> (p.96))
 - * Stopping the buzzer (<sound> (p.97))
 - * Recovery from errors that can be recovered from (<recovery> (p.104))
 - * Reset (<reset> (p.105))
 - * Sending commands in real time (<command> (p.99))

Example

Empty printing document

```
<epos-print xmlns="http://www.epson-pos.com/schemas/2011/03/epos-print" />
```

Drawer kick-out when offline (paper end)

```
<epos-print xmlns="http://www.epson-pos.com/schemas/2011/03/epos-print"
  force="true">
  <pulse />
</epos-print>
```

<response>

An XML document, a printer returns to a host as a response.
This document sends the printer status after command execution.



The response timing varies depending on the printer status.

- When the power is turned ON: Time set to the TM printer
- When the power is turned OFF: Client timeout time
- When printing, return a response in the following timing:
 - * An error occurred: Return an error response before printing.
 - * Printing succeeded: Return a success response after printing.

Attribute

- success : (data type xs:boolean)
Obtains the print result.

Attribute value	Description
true or 1	<ul style="list-style-type: none"> • Printing succeeded • Processing succeeded (When the spooler function is enabled)
false or 0	<ul style="list-style-type: none"> • Printing Failed • Processing Failed (When the spooler function is enabled)

- code : (data type xs:string)
Obtains the error code.

Attribute value	Description
EPTR_AUTOMATICAL	An automatically recoverable error occurred
EPTR_BATTERY_LOW	No remaining battery
EPTR_COVER_OPEN	A cover open error occurred
EPTR_CUTTER	An autocutter error occurred
EPTR_MECHANICAL	A mechanical error occurred
EPTR_REC_EMPTY	No paper in roll paper end sensor
EPTR_UNRECOVERABLE	An unrecoverable error occurred
SchemaError	The request document contains a syntax error
DeviceNotFound	The printer with the specified device ID does not exist
PrintSystemError	An error occurred on the printing system
EX_BADPORT	An error was detected on the communication port
EX_TIMEOUT	A print timeout occurred
EX_SPOOLER *	There is not enough space available in the printing queue
JobNotFound *	The specified job ID does not exist
Printing *	Print job now printing

* ePOS-Print Service Ver.4.1 or later versions supported

- status : (data type xs:unsignedInt)
Obtains the printer status.

Attribute value	Description
0x00000001	No response from the TM printer
0x00000002	Printing is successfully completed
0x00000004	Status of the 3rd pin of the drawer kick-out connector = "H"
0x00000004	Off line status from remaining battery (only for applicable devices) (in ePOS-Print Service Ver.2.2 and later)
0x00000008	Offline
0x00000020	The cover is open
0x00000040	Paper is being fed by a paper feed switch operation
0x00000100	Waiting to be brought back online
0x00000200	The paper feed switch is being pressed (ON)
0x00000400	A mechanical error occurred
0x00000800	An autocutter error occurred
0x00002000	An unrecoverable error occurred
0x00004000	An automatically recoverable error occurred
0x00020000	No paper in roll paper near end sensor
0x00080000	No paper in roll paper end sensor
0x01000000	A buzzer is on (only for applicable devices)
0x01000000	Waiting period for removal of label(only for applicable devices)
0x40000000	No paper in label peeling sensor (only for applicable devices)
0x80000000 *	The spooler has stopped

* ePOS-Print Service Ver.4.1 or later versions supported

- battery : (data type xs:unsignedInt)
The battery status of the printer is obtained.
0 is indicated when the model doesn't have a battery installed.

Status of power

Attribute value	Description
0x30XX	The AC adapter is connected
0x31XX	The AC adapter is not connected

Remaining battery

Attribute value	Description
0xXX36	Battery amount 6
0xXX35	Battery amount 5
0xXX34	Battery amount 4
0xXX33	Battery amount 3
0xXX32	Battery amount 2
0xXX31	Battery amount 1 (Near end)
0xXX30	Battery amount 0 (Real end)

Example

When paper runs out while printing and printing fails.

```
<response xmlns="http://www.epson-pos.com/schemas/2011/03/epos-print"
  success="false" code="EPTR_REC_EMPTY" status="252641308"
  battery="0" />
```

Example of printing failure when battery runs out during printing

```
<response xmlns="http://www.epson-pos.com/schemas/2011/03/epos-print"
  success="false" code="EPTR_BATTERY_LOW"
  status="251658268" battery="12592" />
```

Element

<text>

Prints a character string. Also, configure the string-related settings such as style, print position, and line feed space.



- After printing text, to print content other than text content, execute line feed or paper feed.
- In page mode, characters are laid out in the current print position with the reference point being the character baseline dot ([Support Information by Printer \(p.106\)](#)).

Entity Reference

To write symbols required for printer control such as horizontal tab, line feed, and the following symbols, use their corresponding entity references shown as follows:

Function (symbol)	Entity Reference
&	&
'	'
>	>
<	<
"	"
Horizontal tab(HT)		 or 	
Line feed (LF)	
 or

Attribute

- lang : (data type xs:language)
Specifies the target language.

Attribute value	Description
en(default)	English(ANK)
de	German (ANK)
fr	French (ANK)
it	Italian (ANK)
es	Spanish (ANK)
ja	Japanese (International character set changes to Japan.)
ja-jp	Japanese (International character set changes to Japan.)
ko	Korean (International character set changes to Korean.)
ko-kr	Korean (International character set changes to Korean.)
zh-hans *	Simplified Chinese (International character set changes to China.)
zh-cn	Simplified Chinese (International character set changes to China.)
zh-hant *	Traditional Chinese
zh-tw	Traditional Chinese
Language code besides above	English(ANK)

* ePOS-Print Service Ver.2.2 or later versions supported



- Characters not installed in a printer cannot be printed.
- For printable character code, refer to the detailed instruction manual of your printer.

Depending on language specification, a part of characters is printed as follows.

Language	Characters \$(U+0024)	Characters \ (U+005C)
Japanese	\$	¥
Korean	\$	₩
Simplified Chinese	¥	\
Traditional Chinese	\$	\

- font : (data type tns:font)
Specifies the character font.

Attribute value	Description
font_a (default)	Font A
font_b	Font B
font_c	Font C
font_d *	Font D
font_e *	Font E

* ePOS-Print Service Ver.3.2 or later versions supported



When Japanese is specified, characters in Shift-JIS can be printed.

- smooth : (data type xs:boolean)
Sets smoothing. When smoothing is enabled, the print quality of characters will be improved.

Attribute value	Description
true or 1	Specifies smoothing.
false or 0 (default)	Cancels smoothing

- dw : (data type xs:boolean)
Sets the double-sized width.

Attribute value	Description
true or 1	Specifies the double-sized width.
false or 0 (default)	Cancels the double-sized width



When the double-sized width attribute and the width attribute are specified in one element at the same time, priority is given to the scale specification for the width attribute.

- dh : (data type xs:boolean)
Sets the double-sized height.

Attribute value	Description
true or 1	Specifies the double-sized height
false or 0 (default)	Cancels the double-sized height



When the double-sized height attribute and the height attribute are specified in one element at the same time, priority is given to the scale specification for the height attribute.

- width : (data type tns:text-scale)
Specifies the horizontal scale.

Attribute value	Description
Integer from 1 to 8 (default : 1)	Horizontal scale



When the double-sized width attribute and the width attribute are specified in one element at the same time, priority is given to the scale specification for the width attribute.

- height : (data type tns:text-scale)
Specifies the vertical scale.

Attribute value	Description
Integer from 1 to 8 (default : 1)	Vertical scale



When the double-sized height attribute and the height attribute are specified in one element at the same time, priority is given to the scale specification for the height attribute.

- reverse : (data type xs:boolean)
Sets the inversion of black and white parts of characters.

Attribute value	Description
true or 1	Specifies the inversion of black and white parts of characters.
false or 0 (default)	Cancels the inversion of black and white parts of characters.

- ul : (data type xs:boolean)
Sets underlining.

Attribute value	Description
true or 1	Specifies underlining.
false or 0 (default)	Cancels underlining.

- em : (data type xs:boolean)
Sets emphasized printing.

Attribute value	Description
true or 1	Specifies emphasized printing.
false or 0 (default)	Cancels emphasized printing.

- color : (data type tns:color)
Specifies the character color.

Attribute value	Description
none	Characters are not printed.
color_1 (default)	First color
color_2	Second color
color_3	Third color
color_4	Fourth color

- x : (data type xs:unsignedShort Default : 0)
Specifies the print start position of the text in dots.
In page mode, this specification is the same as the specification for the horizontal print position by the position element, but the print position in the horizontal direction only will be moved.

- **y :** (data type xs:unsignedShort Default : 21)
Specifies the vertical print start position of the text. (in ePOS-Print Service Ver.3.0 and later)
In page mode, the specification is the same as the specification for the vertical print position by the osition element, but the print position in the vertical direction only will be moved.



Use this attribute inside the page element.

- **align :** (data type tns:align)
Specifies the alignment.

Attribute value	Description
left (default)	Alignment to the left
center	Alignment to the center
right	Alignment to the right



- For the standard mode, specify the align attribute "when at the start of a line".
- The align attribute set in this element also applies to the align attribute in each of the image, logo, barcode, and symbol elements.

- **rotate :** (data type xs:boolean)
Sets rotated printing of text.

Attribute value	Description
true or 1	Specifies rotated printing of text.
false or 0 (default)	Cancel rotated printing of text.



- In page mode, even if rotate is specified, it is disabled.
For the page mode, set the print direction as right to left (right_to_left) using the direction element to perform 180-degree rotated printing of text.
- The rotate attribute set in this element also applies to the rotate attribute in each of the barcode and symbol elements.

- **linespc :** (data type xs:unsignedShort Default : 30)
Specifies the per-line paper feed amount in dots.

Example

To print a character string based on the following settings:

Item	Setting
Language	English
Smoothing	Enable
Align	Center Align
Font	Font A
Double-sizing	Double width and height characters
Underline	Enable

```
<epos-print xmlns="http://www.epson-pos.com/schemas/2011/03/epos-print">
  <text lang="en" />
  <text smooth="true" />
  <text align="center" />
  <text font="font_a" />
  <text dw="true" dh="true" />
  <text ul="true" />
  <text>Hello, World!&#10;</text>
</epos-print>
```

Examples for setting the language

- To set the language as Korean:

```
<epos-print xmlns="http://www.epson-pos.com/schemas/2011/03/epos-print">
  <text lang="ko" />
</epos-print>
```

- To set the language as Simplified Chinese:

```
<epos-print xmlns="http://www.epson-pos.com/schemas/2011/03/epos-print">
  <text lang="zh-hans" />
</epos-print>
```

- To set the language as Traditional Chinese:

```
<epos-print xmlns="http://www.epson-pos.com/schemas/2011/03/epos-print">
  <text lang="zh-hant" />
</epos-print>
```

<feed>

Feeds paper. Specifies the paper feed amount in dots or in lines. When no paper feed amount is specified, performs single-line paper feed (line feed). In addition, the per-line line feed space can be set.

Attribute

- unit : (data type xs:unsignedByte)
Specifies the paper feed amount in dots.
- line : (data type xs:unsignedByte)
Specifies the paper feed amount in lines.
- linespc : (data type xs:unsignedByte, Default : 30)
Specifies the per-line paper feed amount in dots.
- pos : (data type tns:feed-pos)
It specifies paper feed position of label paper/black mark paper (in ePOS-Print Service Ver.2.1 and later).

Attribute value	Description
peeling	Paper feed to the peeling position
cutting	Paper feed to the cutting position
current_tof	Paper feed to the head position of current label
next_tof	Paper feed to the head position of next label



- Control of label paper/black mark paper must be done in the standard mode. In the page mode, pos cannot be specified.
- When the per-line paper feed amount is 30 dots, up to 240 lines can be specified.
- The standard mode retains the line feed space separate from the line feed space retained by the page mode. When the linespc attribute is specified in this element, it will affect the linespc attribute in each of the <text> and <feed> elements that follow.

Example

To feed paper 3 lines forward:

```
<epos-print xmlns="http://www.epson-pos.com/schemas/2011/03/epos-print">
  <feed line="3" />
</epos-print>
```

To start a new line after printing a character string:

```
<epos-print xmlns="http://www.epson-pos.com/schemas/2011/03/epos-print">
  <text>Hello</text><feed />
  <text>World</text><feed />
</epos-print>
```

To print while peeling the label one by one

```
<epos-print xmlns="http://www.epson-pos.com/schemas/2011/03/epos-print">
  <feed pos="current_tof" />
  <barcode type="code39" hri="below">0001</barcode>
  <feed pos="peeling" />
</epos-print>
```

To print labels consecutively

```
<epos-print xmlns="http://www.epson-pos.com/schemas/2011/03/epos-print">
  <feed pos="current_tof" />
  <barcode type="code39" hri="below">0001</barcode>
  <feed pos="next_tof" />
  <barcode type="code39" hri="below">0002</barcode>
  <feed pos="next_tof" />
  <barcode type="code39" hri="below">0003</barcode>
  <feed pos="next_tof" />
</epos-print>
```

To print tickets with black mark paper

```
<epos-print xmlns="http://www.epson-pos.com/schemas/2011/03/epos-print">
  <feed pos="current_tof" />
  <barcode type="code39" hri="below">0001</barcode>
  <feed pos="cutting" />
  <cut type="no_feed" />
</epos-print>
```

<image>

Print a raster graphic bit-image. (Data type xs:base64Binary)

Raster graphics refer to data generated by horizontally scanning the pixels of an image from the top left corner of that image as the origin point.

Data is generated based on 1 bit per pixel for two-tone images, and 4 bits per pixel for 16-tone images, starting with the upper bits of byte data. And zero-padding is performed so that scan data per line can be treated on a byte basis.



- In page mode, a raster image is laid out in the current print position with the reference point being its bottom left dot. The print position will not move.
- In page mode, set the print position so that a raster image does not extend beyond the print area.
- Multiple tone printing is not supported in Page Mode. Multiple tone graphic printing is supported in Standard Mode only.
- When multiple tones are set for raster images, intermitting printing may occur because the amount of data to print increases and white stripes may appear in the print result.
- The scan quality of barcodes/2D-codes printed as multiple-tone raster images cannot be guaranteed. Print them as two-tone images.
- To print a raster image at high speed, specify "left" for the align attribute and specify a multiple of 8 that does not exceed the printer paper width for the width attribute value.
- To create raster graphic bit-images, use the ePOS-Print XML generator tool or your own application. Note the following when creating raster graphic images using your own application.
Two-tone image: Specify a multiple of 8 for the image width or fill the missing bits with zeros.
16-tone image: Specify a multiple of 2 for the image width or fill the missing bits with zeros.

Attribute

- width : (Required attribute, data type xs:unsignedShort)
Specifies the image width in dots.
- height : (Required attribute, data type xs:unsignedShort)
Specifies the image height in dots.
- color : (Optional attribute, data type tns:color)
Specifies the character color.

Attribute value	Description
none	Characters are not printed.
color_1 (default)	First color
color_2	Second color
color_3	Third color
color_4	Fourth color

- align : (data type tns:align)
Specifies the print position.

Attribute value	Description
left (default)	Alignment to the left
center	Alignment to the center
right	Alignment to the right



The align attribute set in this element also applies to the align attribute in each of the text, logo, barcode, and symbol elements.

- mode : (Optional attribute, data type tns:image-mode)
Specifies the color mode.

Attribute value	Description
mono (default)	Monochrome (two-tone)
gray16	Multiple tones (16-tone)

Example

To print an 8 dot wide, 8 dot high filled-in raster image:

```
<epos-print xmlns="http://www.epson-pos.com/schemas/2011/03/epos-print">
  <image width="8" height="8">/////////8=</image>
</epos-print>
```

<logo>

Prints a logo registered in the NV memory of the printer.



- Using model-dedicated utility or logo registration utility (TMFLogo), register a logo in the printer in advance.
- Multiple tone printing is not supported in Page Mode. Multiple tone graphic printing is supported in Standard Mode only.
- In page mode, a logo is laid out in the current print position with the reference point being its bottom left dot.

Attribute

- key1 : (Required attribute, data type xs:unsignedByte)
Specifies the value of the key code 1 set at the time of NV logo registration.
- key2 : (Required attribute, data type xs:unsignedByte)
Specifies the value of the key code 2 set at the time of NV logo registration. Be sure to specify this value.
- align : (data type tns:align)
Specifies the print position.

Attribute value	Description
left (default)	Alignment to the left
center	Alignment to the center
right	Alignment to the right



The align attribute set in this element also applies to the align attribute in each of the text, image, barcode, and symbol elements.

Example

To print a NV logo with key1 registered as 48 and key2 registered as 48:

```
<epos-print xmlns="http://www.epson-pos.com/schemas/2011/03/epos-print">  
  <logo key1="48" key2="48" />  
</epos-print>
```

<barcode>

Prints a barcode.

Specifies the barcode data using a character string. (Data type xs:string)



- A barcode will not be printed if settings not compliant with the barcode standard are made, or if the barcode becomes larger than the printer's print area. And an error response will not be returned, either.
- In page mode, a barcode is laid out in the current print position with the reference point being its bottom left dot (except for HRI).

Barcode Type

The following barcodes can be specified:

Barcode type	Barcode data specification procedure
UPC-A	When an 11-digit number is specified, a check digit is automatically added. When a 12-digit number is specified, the 12th digit is processed as a check digit but the check digit is not validated.
UPC-E	Specify 0 as the first digit. Specify the manufacturer code in the digits 2 to 6. Specify (right-align) the item code in the digits 7 to 11. The number of item code digits varies depending on the manufacturer code. Specify 0s in empty digits. When an 11-digit number is specified, a check digit is automatically added. When a 12-digit number is specified, the 12th digit is processed as a check digit but the check digit is not validated.
EAN13	When an 12-digit number is specified, a check digit is automatically added.
JAN13	When a 13-digit number is specified, the 12th digit is processed as a check digit but the check digit is not validated.
EAN8	When a 7-digit number is specified, a check digit is automatically added.
JAN8	When an 8-digit number is specified, the 8th digit is processed as a check digit but the check digit is not validated.
CODE39	When the first character is *, the character is processed as the start character. In other cases, a start character is automatically added.
ITF	Start and stop codes are automatically added. Check digits are not added or validated.
CODABAR	Specify a start character (A to D, a to d). Specify a stop character (A to D, a to d). Check digits are not added or validated.
CODE93	Start and stop characters are automatically added. A check digit is automatically calculated and added.

Barcode type	Barcode data specification procedure																		
CODE128	<p>Specify a start character (CODE A, CODE B, CODE C). A stop character is automatically added. A check digit is automatically calculated and added. To encode each of the following characters, specify two characters starting with the character "{":</p> <table data-bbox="598 465 845 808"> <tr><td>FNC1:</td><td>{1</td></tr> <tr><td>FNC2:</td><td>{2</td></tr> <tr><td>FNC3:</td><td>{3</td></tr> <tr><td>FNC4:</td><td>{4</td></tr> <tr><td>CODE A:</td><td>{A</td></tr> <tr><td>CODE B:</td><td>{B</td></tr> <tr><td>CODE C:</td><td>{C</td></tr> <tr><td>SHIFT:</td><td>{S</td></tr> <tr><td>{:</td><td>{{</td></tr> </table>	FNC1:	{1	FNC2:	{2	FNC3:	{3	FNC4:	{4	CODE A:	{A	CODE B:	{B	CODE C:	{C	SHIFT:	{S	{:	{{
FNC1:	{1																		
FNC2:	{2																		
FNC3:	{3																		
FNC4:	{4																		
CODE A:	{A																		
CODE B:	{B																		
CODE C:	{C																		
SHIFT:	{S																		
{:	{{																		
GS1-128	<p>A start character, FNC1, a check digit, and a stop character are automatically added. To automatically calculate and add a check digit for an application identifier (AI) and the subsequent data, specify the character "*" in the position of the check digit. You can enclose an application identifier (AI) in parentheses. The parentheses are used as HRI print characters and are not encoded as data. You can insert spaces between an application identifier (AI) and data. The spaces are used as HRI print characters and are not encoded as data. To encode each of the following characters, specify two characters starting with the character "{":</p> <table data-bbox="598 1301 845 1525"> <tr><td>FNC1:</td><td>{1</td></tr> <tr><td>FNC3:</td><td>{3</td></tr> <tr><td>(:</td><td>{{</td></tr> <tr><td>):</td><td>{}</td></tr> <tr><td>*:</td><td>{*</td></tr> <tr><td>{:</td><td>{{</td></tr> </table>	FNC1:	{1	FNC3:	{3	(:	{{):	{}	*:	{*	{:	{{						
FNC1:	{1																		
FNC3:	{3																		
(:	{{																		
):	{}																		
:	{																		
{:	{{																		
GS1 DataBar Omnidirectional	Specify a 13-digit global trade item number (GTIN) not including an application identifier (AI) or a check digit.																		
GS1 DataBar Truncated																			
GS1 DataBar Limited																			
GS1 DataBar Expanded	<p>You can enclose an application identifier (AI) in parentheses. The parentheses are used as HRI print characters and are not encoded as data. To encode each of the following characters, specify two characters starting with the character "{":</p> <table data-bbox="598 1877 845 1980"> <tr><td>FNC1:</td><td>{1</td></tr> <tr><td>(:</td><td>{{</td></tr> <tr><td>):</td><td>{}</td></tr> </table>	FNC1:	{1	(:	{{):	{}												
FNC1:	{1																		
(:	{{																		
):	{}																		

To specify binary data that cannot be represented by character strings, use the following escape sequences.

String	Description
\xnn	Control code
\\	Back slash

Attribute

- **type** : (Required attribute, data type tns:barcode-type)
Specifies the barcode type.

Attribute value	Description
upc_a	UPC-A
upc_e	UPC-E
ean13	EAN13
jan13	JAN13
ean8	EAN8
jan8	JAN8
code39	CODE39
itf	ITF
codabar	CODABAR
code93	CODE93
code128	CODE128
gs1_128	GS1-128
gs1_databar_omnidirectional	GS1 DataBar Omnidirectional
gs1_databar_truncated	GS1 DataBar Truncated
gs1_databar_limited	GS1 DataBar Limited
gs1_databar_expanded	GS1 DataBar Expanded

- **hri** : (data type tns:barcode-hri)
Specifies the HRI position.

Attribute value	Description
none (default)	HRI not printed
above	Above the bar code
below	Below the bar code
both	Both above and below the bar code

- **font** : (data type tns:font)
Specifies the HRI font.

Attribute value	Description
font_a (default)	Font A
font_b	Font B
font_c	Font C
font_d *	Font D
font_e *	Font E

* ePOS-Print Service Ver.3.2 or later versions supported

- width : (data type xs:unsignedByte Default "3")
Specifies the width of each module in dots. Specifies an integer from 2 to 6.
- height : (data type xs:unsignedByte Default "162")
Specifies the barcode height in dots.
- align : (data type tns:align)
Specifies the print position.

Attribute value	Description
left (default)	Alignment to the left
center	Alignment to the center
right	Alignment to the right



The align attribute set in this element also applies to the align attribute in each of the text, image, logo, and symbol elements.

- rotate : (data type xs:boolean)
Specifies the rotate printing.

Attribute value	Description
true or 1	Specifies rotated printing of text.
false or 0 (default)	Cancels rotated printing of text.



- For the standard mode, specify the rotate attribute "when at the start of a line".
- In page mode, even if rotate is specified, it is disabled.
- In the page mode, set the printing direction to "right_to_left" with "direction" and conduct 180 rotation printing.
- The rotate attribute set in this element also applies to the rotate attribute in each of the text and symbol elements.

Example

To print barcodes:

```

epos-print xmlns="http://www.epson-pos.com/schemas/2011/03/epos-print">
  <barcode type="upc_a" width="2" height="64" hri="below">01234567890</barcode>
  <barcode type="upc_e">01234500005</barcode>
  <barcode type="ean13">201234567890</barcode>
  <barcode type="jan13">201234567890</barcode>
  <barcode type="ean8">2012345</barcode>
  <barcode type="jan8">2012345</barcode>
  <barcode type="code39">ABCDE</barcode>
  <barcode type="itf">012345</barcode>
  <barcode type="codabar">A012345A</barcode>
  <barcode type="code93">ABCDE</barcode>
  <barcode type="code128">{Babcde</barcode>
  <barcode type="gs1_128">(01)201234567890*</barcode>
  <barcode type="gs1_databar_omnidirectional">0201234567890</barcode>
  <barcode type="gs1_databar_truncated">0201234567890</barcode>
  <barcode type="gs1_databar_limited">0201234567890</barcode>
  <barcode type="gs1_databar_expanded">(01)2012345678903</barcode>
</epos-print>

```

<symbol>

Prints a 2D-code.

Specifies the 2D-code using a character string. (Data type `xs:string`)



- A 2D-code will not be printed if settings not compliant with the 2D-code standard are made, or if the 2D-code becomes larger than the printer's print area. And an error response will not be returned, either.
- In standard mode, a more than 831 dot high 2D-code cannot be printed.
- In page mode, a 2D-code is laid out in the current print position with the reference point being its top left dot.

2D-code Type

The following 2D-codes can be specified:

Type	Description
PDF417	Convert the character string to the string in UTF-8, apply the escape sequence, and then encode the string. The data area can contain up to 928 code words in a maximum of 90 rows, each of which can contain up to 30 code words.
QR Code	Convert the character string to the string in Shift-JIS, apply the escape sequence, and then encode the string based on the data type as shown below. Number: 0 to 9 Alphanumeric character: 0 to 9, A to Z, space, \$, %, *, +, -, ., /, : Kanji character: Shift-JIS value 8-bit, byte data: 0x00 to 0xff
Micro QR Code	
MaxiCode	Convert the character string to the string in UTF-8, apply the escape sequence, and then encode the string. In Modes 2 and 3, when the first piece of data is <code>()>\x1e01\x1ddy</code> (where <code>yy</code> is a two-digit number), this is processed as the message header, and the subsequent data is processed as the primary message. In other cases, from the first piece of data, data is processed as the primary message. In Mode 2, specify the primary message in the following format: Postal code (1- to 9-digit number) GS:(\x1d) ISO country code (1- to 3-digit number) GS:(\x1d) Service class code (1- to 3-digit number) In Mode 3, specify the primary message in the following format: Postal code (1 to 6 pieces of data convertible by Code Set A) GS:(\x1d) ISO country code (1- to 3-digit number) GS:(\x1d) Service class code (1- to 3-digit number)
GS1 DataBar Stacked	Convert the character string to the string in UTF-8, apply the escape sequence, and then encode the string. Specify a 13-digit global trade item number (GTIN) not including an application identifier (AI) or a check digit.
GS1 DataBar Stacked Omnidirectional	

Type	Description
GS1 DataBar Expanded Stacked	Convert the character string to the string in UTF-8, apply the escape sequence, and then encode the string. You can enclose an application identifier (AI) in parentheses. The parentheses are used as HRI print characters and are not encoded as data. To encode each of the following characters, specify two characters starting with the character "{": FNC1: {1 (: {(): })
Aztec Code	After converting the character string to UTF-8, conduct the escape sequence and encode.
DataMatrix	After converting the character string to UTF-8, conduct the escape sequence and encode.

To specify binary data that cannot be represented by character strings, use the following escape sequences.

String	Description
\xnn	Control code
\\	Back slash

Attribute

- type : (Required attribute, data type tns:symbol-type)
Specifies the 2D-code type.

Attribute value	Type
pdf417_standard	Standard PDF417
pdf417_truncated	Truncated PDF417
qrcode_model_1	QR Code Model 1
qrcode_model_2	QR Code Model 2
qrcode_micro *2	Micro QR Code
maxicode_mode_2	MaxiCode Mode 2
maxicode_mode_3	MaxiCode Mode 3
maxicode_mode_4	MaxiCode Mode 4
maxicode_mode_5	MaxiCode Mode 5
maxicode_mode_6	MaxiCode Mode 6
gs1_databar_stacked	GS1 DataBar Stacked
gs1_databar_stacked_omnidirectional	GS1 DataBar Stacked Omnidirectional
gs1_databar_expanded_stacked	GS1 DataBar Expanded Stacked
azteccode_fullrange *1	Aztec Code Full-Range Mode
azteccode_compact *1	Aztec Code Compact Mode
datamatrix_square *1	DataMatrix ECC200 square
datamatrix_rectangle_8 *1	DataMatrix ECC200 rectangle, 8 lines
datamatrix_rectangle_12 *1	DataMatrix ECC200 rectangle, 12 lines
datamatrix_rectangle_16 *1	DataMatrix ECC200 rectangle, 16 lines

*1 ePOS-Print Service Ver.2.2 or later versions supported

*2 ePOS-Print Service Ver.4.1 or later versions supported

- **level :** (data type tns:symbol-level)
Specifies the error correction level.

Attribute value	Description
level_0	PDF417 error correction level 0
level_1	PDF417 error correction level 1
level_2	PDF417 error correction level 2
level_3	PDF417 error correction level 3
level_4	PDF417 error correction level 4
level_5	PDF417 error correction level 5
level_6	PDF417 error correction level 6
level_7	PDF417 error correction level 7
level_8	PDF417 error correction level 8
level_l	QR Code error correction level L
level_m	QR Code error correction level M
level_q	QR Code error correction level Q
level_h	QR Code error correction level H
Integer from 5 to 95 *	Aztec Code error correction level (Default : 23)
default	Default level

* ePOS-Print Service Ver.2.2 or later versions supported



- Select the level according to the 2D-code type.
- Select the default for MaxiCode and two-dimensional GS1 DataBar.
- Micro QR Code does not support level_h.

- **width :** (data type xs:unsignedByte)
Specifies the width of each module in dots.

2D-Code Type	Valid value range	Default
PDF417	2 to 8	width="3"
QR Code	3 to 16	width="3"
MaxiCode	Ignored	
2-dimensional GS1 DataBar	2 to 8	width="2"
Aztec Code	2 to 16	width="3"
DataMatrix	2 to 16	width="3"

- height : (data type xs:unsignedByte)
Specifies the height of each module.

2D-Code Type	Valid value range	Default
PDF417	2 to 8 (Magnification for width)	height="3"
QR Code	Ignored	
MaxiCode		
GS1 DataBar		
Aztec Code		
DataMatrix		

- size : (data type xs:unsignedShort)

2D-Code	Default	Description
PDF417	size="0"	Specifies the number of code words for each row
QR Code	Ignored	
MaxiCode		
2-dimensional GS1 DataBar		
Expanded Stacked	size="0" (auto)	Specifies the maximum width for the barcode (106 or above)
Others	Ignored	
Aztec Code	Ignored	
DataMatrix		

- align : (data type tns:align)
Specifies the print position.

Attribute value	Description
left (default)	Alignment to the left
center	Alignment to the center
right	Alignment to the right



The align attribute set in this element also applies to the align attribute in each of the text, image, logo, and barcode elements.

- rotate : (data type xs:boolean)
Specifies the rotate printing.

Attribute value	Description
true or 1	Specifies rotated printing of text.
false or 0 (default)	Cancels rotated printing of text.



- For the standard mode, specify the rotate attribute "when at the start of a line".
- In page mode, even if rotate is specified, it is disabled.
- In the page mode, set the printing direction to "right_to_left" with "direction" and conduct 180 rotation printing.
- The rotate attribute set in this element also applies to the rotate attribute in each of the text and barcode elements.

Example

To print 2D-codes:

```
<epos-print xmlns="http://www.epson-pos.com/schemas/2011/03/epos-print">
  <symbol type="pdf417_standard">ABCDE</symbol>
  <symbol type="qrcode_model_2" level="level_q">ABCDE</symbol>
  <symbol type="maxicode_mode_2">908063840\x1d850\x1d001\x1d\x04</symbol>
  <symbol type="gs1_databar_stacked">0201234567890</symbol>
  <symbol type="gs1_databar_stacked_omnidirectional">0201234567890</symbol>
  <symbol type="gs1_databar_expanded_stacked">(01)02012345678903</symbol>
  <symbol type="azteccode_fullrange" level="23">ABCDE</symbol>
  <symbol type="datamatrix_square">ABCDE</symbol>
</epos-print>
```

<hline>

Draws horizontal lines.



Cannot be written in the <page> tag.

Attribute

- x1 : (Required attribute, data type xs:unsignedShort)
Specifies the draw start position of the horizontal line (in dots).
- x2 : (Required attribute, data type xs:unsignedShort)
Specifies the draw end position of the horizontal line (in dots).
- style : (Optional attribute, data type tns:line-style)
Specifies the line type.

Attribute value	Description
thin(default)	Solid line: Thin
medium	Solid line: Medium
thick	Solid line: Thick
thin_double	Double line: Thin
medium_double	Double line: Medium
thick_double	Double line: Thick

Example

To draw double lines in the following positions:

- From the left end: 100th dot to 200th dot
- From the left end: 400th dot to 500th dot

```
<epos-print xmlns="http://www.epson-pos.com/schemas/2011/03/epos-print">  
  <hline x1="100" x2="200" style="thin_double" />  
  <hline x1="400" x2="500" style="thin_double" />  
</epos-print>
```

<vline-begin>

Starts to draw vertical lines.



- A vertical line is drawn up to the end position specified by the vline-end element (p. 88). Use this element together with the vline-end element.
- Cannot be written in the <page> tag.

Attribute

- x : (Required attribute, data type xs:unsignedShort)
Specifies the start position of the horizontal line (in dots).
- style : (Optional attribute, data type tns:line-style)
Specifies the line type.

Attribute value	Description
thin(default)	Solid line: Thin
medium	Solid line: Medium
thick	Solid line: Thick
thin_double	Double line: Thin
medium_double	Double line: Medium
thick_double	Double line: Thick

Example

To draw a thin line from 100th to 200th dot from the left end.

```
<epos-print xmlns="http://www.epson-pos.com/schemas/2011/03/epos-print">
  <vline-begin x="100" />
  <vline-begin x="200" />
  <feed unit="100" />
  <vline-end x="100" />
  <vline-end x="200" />
</epos-print>
```

<vline-end>

Ends to draw vertical lines.



- Use this element together with the vline-begin element (p. 87).
- Cannot be written in the <page> tag.

Attribute

- x : (Required attribute, data type xs:unsignedShort)
Specifies the end position of the horizontal line (in dots).
- style : (Optional attribute, data type tns:line-style)
Specifies the line type.

Attribute value	Description
thin(default)	Solid line: Thin
medium	Solid line: Medium
thick	Solid line: Thick
thin_double	Double line: Thin
medium_double	Double line: Medium
thick_double	Double line: Thick

Example

To draw a thin line from 100th to 200th dot from the left end.

```
<epos-print xmlns="http://www.epson-pos.com/schemas/2011/03/epos-print">  
  <vline-begin x="100" />  
  <vline-begin x="200" />  
  <feed unit="100" />  
  <vline-end x="100" />  
  <vline-end x="200" />  
</epos-print>
```

<page>

Changes the mode from standard mode to page mode.

Elements via <page>

Via <page>, the following elements can be used.

Element	Description
<text>	Prints text
<feed>	Paper feed
<image>	Prints a raster image
<logo>	Prints a NV logo
<barcode>	Prints a barcode
<symbol>	Prints a 2D-code
<area>	Sets a print area
<direction>	Sets a print direction
<position>	Sets a print position
<line>	Draws a line
<rectangle>	Draws a rectangle
<command>	Inserts a command

Example

To print "ABCDE" in page mode:

```
<epos-print xmlns="http://www.epson-pos.com/schemas/2011/03/epos-print">
  <page>
    <text>ABCDE</text>
  </page>
</epos-print>
```

<area>

Specifies the page mode print area.

Specifies the origin point, width, and height based on the absolute origin point to set the print area. The absolute origin point is a dot diagonally above the top left corner of the printable area.

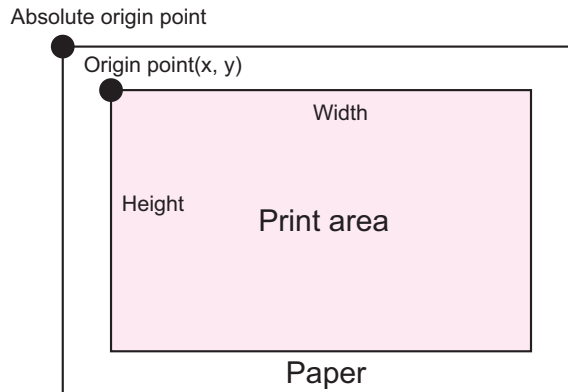

- Use this element inside the page element.
- Specify the print area according to the print content. If print data extends beyond the print area, the print result is such that the whole data cannot be printed completely.

Attribute

- **x :** (Required attribute, data type xs:unsignedShort Default "0")
Specifies the origin of the horizontal axis (in dots).
- **y :** (Required attribute, data type xs:unsignedShort Default "0")
Specifies the origin of the vertical axis (in dots).
- **width :** (Required attribute, data type xs:unsignedShort Default :Differ according to each model)
Specifies the width of the print area (in dots).
- **height :** (Required attribute data type xs:unsignedShort Default :Differ according to each model)
Specifies the height of the print area (in dots).



Determine the width and height of the print area according to the print direction setting. Otherwise, the print data might not be printed completely.

Example

To print the characters "ABCDE" by specifying the print area as origin (100, 50), width: 200 dots, and height: 30 dots:

```
<epos-print xmlns="http://www.epson-pos.com/schemas/2011/03/epos-print">
  <page>
    <area x="100" y="50" width="200" height="30" />
    <text>ABCDE</text>
  </page>
</epos-print>
```

<direction>

Specifies the page mode print direction.

Specifies the print direction and rotates the print area. Following the rotation of the print area, the start point of the print area moves.



Use this element inside the page element.

Attribute

- dir : (Required attribute, data type tns:page-dir)
Specifies the rotation direction.

Attribute value	Description
left_to_right (default)	Left to right (No rotation. Data is printed from the top left corner to the right.)
bottom_to_top	Bottom to top (Counterclockwise rotation by 90 degrees. Data is printed from the bottom left corner to the top.)
right_to_left	Right to left (Rotation by 180 degrees. Data is printed from the bottom right corner to the left.)
top_to_bottom	Top to bottom (Clockwise rotation by 90 degrees. Data is printed from the top right corner to the bottom.)

Example

To print the characters "ABCDE" by rotating them 90 degrees clockwise:

```
<epos-print xmlns="http://www.epson-pos.com/schemas/2011/03/epos-print">
  <page>
    <direction dir="top_to_bottom" />
    <text>ABCDE</text>
  </page>
</epos-print>
```

<position>

Specifies the page mode print position.

Specifies the print position based on the start point of the print area. The start point of the print area moves by following the rotation of the print area.



Use this element inside the page element.

Attribute

- **x :** (Required attribute, data type xs:unsignedShort Default "0")
Specifies the origin of the horizontal axis (in dots).
- **y :** (Required attribute, data type xs:unsignedShort Default "21")
Specifies the origin of the vertical axis (in dots).



Specify the print start position (coordinates) according to the content to be printed. Refer to the following.

- * To print a character string:
Specify the left end of the baseline for the first character. This can be omitted for left-aligned printing of standard-sized characters. To print double-sized height characters, specify a value equal to or greater than 42 for y.
- * To print a barcode:
Specify the bottom left of the symbol. And specify the barcode height for y.
- * To print a graphic/logo:
Specify the bottom left of the graphic data. And specify the graphic data height for y.
- * To print a 2D-code:
Specify the top left of the symbol. This can be omitted when printing from the top left.

Example

To specify (50,30) for the print start position in the area specified by the `addPageArea` method and print the characters "ABCDE":

```
<epos-print xmlns="http://www.epson-pos.com/schemas/2011/03/epos-print">
  <page>
    <area x="100" y="50" width="200" height="100" />
    <position x="50" y="30" />
    <text>ABCDE</text>
  </page>
</epos-print>
```

<line>

Draws a line in page mode.



- Use this element inside the page element.
- Diagonal lines cannot be drawn.

Attribute

- **x1**: (Required attribute, data type xs:unsignedShort)
Specifies the drawing start position of the horizontal line (in dots).
- **y1**: (Required attribute, data type xs:unsignedShort)
Specifies the drawing start position of the vertical line (in dots).
- **x2**: (Required attribute, data type xs:unsignedShort)
Specifies the drawing end position of the horizontal line (in dots).
- **y2**: (Required attribute, data type xs:unsignedShort)
Specifies the drawing end position of the vertical line (in dots).
- **style**: (data type tns:line-style)
Specifies the line type.

Attribute value	Description
thin	Solid line: Thin
medium	Solid line: Medium
thick	Solid line: Thick
thin_double	Double line: Thin
medium_double	Double line: Medium
thick_double	Double line: Thick

Example

To draw a thin solid line between the start position (100, 0) and the end position (500, 0):

```
<epos-print xmlns="http://www.epson-pos.com/schemas/2011/03/epos-print">
  <page>
    <line x1="100" y1="0" x2="500" y2="0" style="thin" />
  </page>
</epos-print>
```

<rectangle>

Draws a rectangle in page mode.



- Use this element inside the page element.
- Not available in standard mode. Use the hline, vline-begin, and vline-end elements instead.

Attribute

- x1: (Required attribute, data type xs:unsignedShort)
Specifies the drawing start position of the horizontal line (in dots).
- y1 : (Required attribute, data type xs:unsignedShort)
Specifies the drawing start position of the vertical line (in dots).
- x2 : (Required attribute, data type xs:unsignedShort)
Specifies the drawing end position of the horizontal line (in dots).
- y2 : (Required attribute, data type xs:unsignedShort)
Specifies the drawing end position of the vertical line (in dots).
- style : (data type tns:line-style)
Specifies the line type.

Attribute value	Description
thin	Solid line: Thin
medium	Solid line: Medium
thick	Solid line: Thick
thin_double	Double line: Thin
medium_double	Double line: Medium
thick_double	Double line: Thick

Example

To draw a rectangle with a thin double line, with the start position (100, 0) and the end position (500, 200) as its vertexes:

```
<epos-print xmlns="http://www.epson-pos.com/schemas/2011/03/epos-print">
  <page>
    <rectangle x1="100" y1="0" x2="500" y2="200" style="thin-double" />
  </page>
</epos-print>
```

<cut>

Sets paper cut.



- Cannot be written in the <page> tag.
- Execute "when at the top of a line".

Attribute

- type : (data type tns:cut-type)
Specifies the paper cut type.

Attribute value	Description
no_feed	Cut without feeding (The paper is cut without being fed.)
feed	Feed cut (The paper is fed to the cut position and then is cut.)
reserve	Cut reservation (Printing continues until the cut position is reached, at which the paper is cut.)

Example

To perform feed cut operation:

```
<epos-print xmlns="http://www.epson-pos.com/schemas/2011/03/epos-print">
  <cut type="feed" />
</epos-print>
```

<pulse>

Outputs signals to the drawer kick connector.
Depending on the model, a buzzer can be sounded.



- Cannot be written in the <page> tag.
- The drawer and the buzzer cannot be used together.

Attribute

- drawer : (data type tns:pulse-drawer)
Specifies the drawer kick connector.

Attribute value	Description
drawer_1	Pin 2 of the drawer kick-out connector
drawer_2	Pin 5 of the drawer kick-out connector

- time : (data type tns:pulse-time)
Specifies the ON time of the drawer kick signal.

Attribute value	Description
pulse_100	100 ms
pulse_200	200 ms
pulse_300	300 ms
pulse_400	400 ms
pulse_500	500 ms

Example

To send a 100msec pulse signal to the pin 2 of the drawer kick connector:

```
<epos-print xmlns="http://www.epson-pos.com/schemas/2011/03/epos-print">  
  <pulse drawer="drawer_1" time="pulse_100" />  
</epos-print>
```

<sound>

Sounds a buzzer.



- Cannot be written in the <page> tag.
- The buzzer function and the drawer cannot be used together.
- This element is not available if the printer is not provided with the buzzer.

Attribute

- **pattern** : (data type tns:sound-pattern)
Specifies the buzzer pattern.

Attribute value	Description
none	Stop
pattern_a	Pattern A
pattern_b	Pattern B
pattern_c	Pattern C
pattern_d	Pattern D
pattern_e	Pattern E
error	Error sound pattern
paper_end	Pattern when there is no paper
pattern_1 *	Pattern 1
pattern_2 *	Pattern 2
pattern_3 *	Pattern 3
pattern_4 *	Pattern 4
pattern_5 *	Pattern 5
pattern_6 *	Pattern 6
pattern_7 *	Pattern 7
pattern_8 *	Pattern 8
pattern_9 *	Pattern 9
pattern_10 *	Pattern 10

* ePOS-Print Service Ver.2.2 or later versions supported

- **repeat** : (data type xs:unsignedByte, When not specified : 1)
Specifies the number of repeats.

Attribute value	Description
0	The buzzer does not stop.
1 to 255	Number of repeats

- **cycle** : (data type xs:unsignedByte, When not specified : 1000)
(in ePOS-Print Service Ver.2.2 and later)
Specifies the buzzer sounding cycle (in units of milliseconds)



"cycle" is enabled by any of "pattern_1" to "pattern_10" for the buzzer pattern.

Example

To repeat the sound pattern A three times:

```
<epos-print xmlns="http://www.epson-pos.com/schemas/2011/03/epos-print">  
  <sound pattern="pattern_a" repeat="3" />  
</epos-print>
```

<command>

Insert the ESC / POS command.

ESC / POS command is specified in hexadecimal encoding. (data type xs:hexBinary)



Refer to the following URL for details of the ESC/POS command.

https://reference.epson-biz.com/modules/ref_escpos/index.php?content_id=2

Example

```
<epos-print xmlns="http://www.epson-pos.com/schemas/2011/03/epos-print">  
  <command>41424344450a</command>  
</epos-print>
```

<layout>

To use sheets with black mark or die-cut labels, set the paper layout in advance.
(in ePOS-Print Service Ver.2.2 and later)



Cannot be written in the <page> tag.

Attribute

- type : (data type tns:layout-type)
Specifies the paper type.

Attribute value	Description
receipt (default)	Receipt (without black mark)
receipt_bm	Receipt (with black mark)
label	Die-cut label (without black mark)
label_bm	Die-cut label (with black mark)

- width : (data type xs:unsignedShort, When not specified : 580)
Specifies paper width (in units of 0.1 mm). Specifies an integer from 290 to 600. *
- height : (data type xs:unsignedShort, When not specified : 0)
Specifies paper height (in units of 0.1 mm).

Paper Type	Valid value range	Description
Receipt (without black mark)	0	Setup not necessary
Receipt (with black mark)	0 (auto) 284 to 1550 (manual) *	Distance from the top of black mark to the top of next black mark
Die-cut label (without black mark)		Distance from the top of label to the top of next label
Die-cut label (with black mark)		Distance from the bottom of black mark to the bottom of next black mark

- margin-top : (data type xs:Short, When not specified : 0)
Specifies top margin (in units of 0.1 mm).

Paper Type	Valid value range	Description
Receipt (without black mark)	0	Setup not necessary
Receipt (with black mark)	-150 to 1500 *	Distance from the top of black mark
Die-cut label (without black mark)	0 to 1500 *	Distance from the top of label
Die-cut label (with black mark)	-15 to 1500 *	Distance from the bottom of black mark

- `margin-bottom` : (data type `xs:Short`, When not specified : 0)
Specifies bottom margin (in units of 0.1 mm).

Paper Type	Valid value range	Description
Receipt (without black mark)	0	Setup not necessary
Receipt (with black mark)	0	
Die-cut label (without black mark)	-15 to 0 *	Distance from the bottom of label (paper feed direction is a positive number)
Die-cut label (with black mark)	-15 to 15 *	Distance from the top of black mark (paper feed direction is a positive number)

- `offset-cut` : (data type `xs:Short`)
Specifies cut position (in units of 0.1 mm).
In case of die cut label paper, it is a distance from the bottom of label.
When a paper has black mark, it is a distance from the beginning of black mark.

Paper Type	Valid value range	Description
Receipt (without black mark)	0	Setup not necessary
Receipt (with black mark)	-290 to 50 *	Distance from the top of black mark to the cutting position
Die-cut label (without black mark)	0 to 50 *	Distance from the bottom of label to the cutting position
Die-cut label (with black mark)	0 to 50 *	Distance from the top of black mark to the cutting position

- `offset-label` : (data type `xs:Short`, When not specified : 0)
Specifies label bottom position (sd) per 0.1 mm unit.

Paper Type	Valid value range	Description
Receipt (without black mark)	0	Setup not necessary
Receipt (with black mark)	0	
Die-cut label (without black mark)	0	
Die-cut label (with black mark)	0 to 15 *	Distance from the top of black mark to the bottom of label

*: Valid value of range is depending on the printer model. For detail, refer to [Support Information by Printer \(p.106\)](#).

Detailed description

See below for the parameters that can be specified for each type of paper, and the positions for those parameters.

Mark	Parameter
sf	width
sa	height
sb	margin_top
se	margin_bottom
sc	offset_cut
sd	offset_label

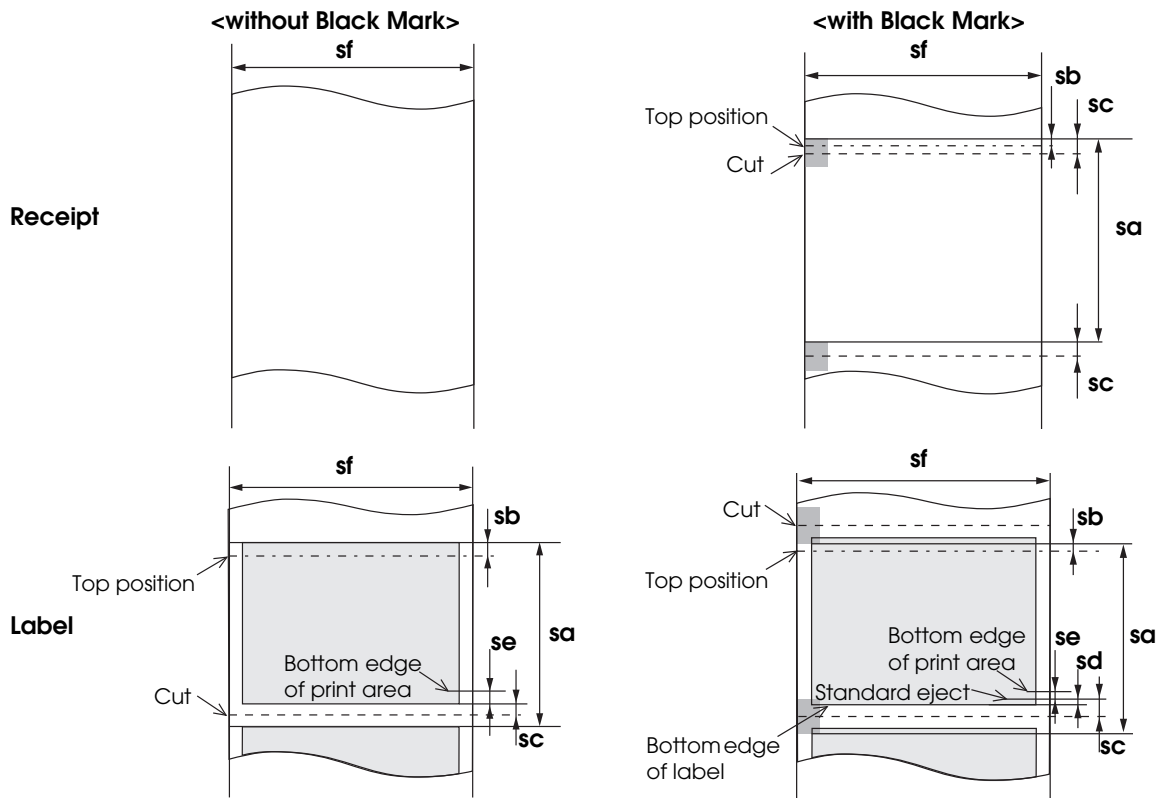

Example*Paper change*

To change paper, it is necessary to change the paper type before printing.

To set 58 mm receipt (without black mark):

```
<epos-print xmlns="http://www.epson-pos.com/schemas/2011/03/epos-print">
  <layout type="receipt" width="580" />
</epos-print>
```

To set 58 mm receipt (with black mark):

```
<epos-print xmlns="http://www.epson-pos.com/schemas/2011/03/epos-print">
  <layout type="receipt_bm" width="580" height="0" margin-top="15" offset-
    cut="0" />
</epos-print>
```

To set 58 mm die-cut label (without black mark):

```
<epos-print xmlns="http://www.epson-pos.com/schemas/2011/03/epos-print">
  <layout type="label" width="580" height="0" margin-top="15" margin-
    bottom="-15" offset-cut="25" />
</epos-print>
```

To set 58 mm die-cut label (with black mark):

```
<epos-print xmlns="http://www.epson-pos.com/schemas/2011/03/epos-print">
  <layout type="label_bm" width="580" height="0" margin-top="15"
    margin-bottom="-15" offset-cut="25" offset-label = "15" />
</epos-print>
```

Setting label paper in TM-P Series printers

For TM-P Series printers (except TM-P60), before printing labels, it is necessary to set the label size and feed label paper. Perform control by referring to the following:

```
<epos-print xmlns="http://www.epson-pos.com/schemas/2011/03/epos-print">

  <!-- Set the paper layout. -->
  <!-- Die-cut label paper, mount width: 58.0 mm, height: automatic -->
  <!-- Top margin: 1.5 mm from label edge, bottom margin: 1.5 mm from label bottom edge -->
  <!-- Cut position: 2.5 mm from label bottom edge -->
  <layout type="label" width="580" height="0" margin-top="15"
    margin-bottom="-15" offset-cut="25" offset-label="0"/>

  <!-- Feeds to the top of the label. -->
  <feed pos="next_tof"/>

</epos-print>
```

<recovery>

Recovers from an error. (in ePOS-Print Service Ver.3.0 and later)



- Cannot be written in the <page> tag.
- Recovers from errors that can be recovered from and clears the buffer.
Enable forced transmission mode ([p. 62](#)) to use this element.

Example

Recovers from errors that can be recovered from and clears the buffer.

```
<epos-print xmlns= "http://www.epson-pos.com/schemas/2011/03/epos-print"
force="true">
  <recovery />
</epos-print>
```

<reset>

Resets the printer. (in ePOS-Print Service Ver.3.0 and later)



- Cannot be written in the <page> tag.
- Other printing commands in the print document are ignored.

Example**Resets the printer**

```
<epos-print xmlns= "http://www.epson-pos.com/schemas/2011/03/epos-print">  
  <reset />  
</epos-print>
```

Support Information by Printer

Model	Page	Model	Page	Model	Page
TM-H6000IV-DT	p. 106	TM-L90-i	p. 108	TM-L90	p. 108
TM-P20	p. 110	TM-P60II	p. 112	TM-P60II with Peeler	p. 112
TM-P80	p. 114	TM-T20	p. 116	TM-T20II-i	p. 117
TM-T20II	p. 117	TM-T70-i	p. 119	TM-T70	p. 119
TM-T70-i Multi-language model	p. 121	TM-T70 Multi-language model	p. 121	TM-T70II-DT	p. 123
TM-T70II	p. 123	TM-T82II-i	p. 125	TM-T82II	p. 125
TM-T83II-i	p. 127	TM-T83II	p. 127	TM-T88IV	p. 129
TM-T88V-DT	p. 131	TM-T88V-i	p. 131	TM-T88V	p. 131
TM-T90	p. 133	TM-U220-i	p. 135	TM-U220	p. 135

TM-H6000IV-DT

		Receipt	
		80 mm	58 mm
Resolution		180 x 180 dpi	
Print Width		512 dots	
Characters in a Line	Font A	ANK: 42 characters	ANK: 30 characters
	Font B	ANK: 56 characters	ANK: 40 characters
Character Size	Font A	ANK: 12 dots x 24 dots (W x H)	
	Font B	ANK: 9 dots x 17 dots (W x H)	
Character Baseline	Font A	At the 21st dot from the top of the character	
	Font B	At the 16th dot from the top of the character	
Default Line Feed Space		30 dots	
Color Specification		First color	
Page Mode Default Area		512 dots x 831 dots (W x H)	360 dots x 831 dots (W x H)
Page Mode Maximum Area		512 dots x 1662 dots (W x H)	360 dots x 1662 dots (W x H)
Raster Image <image>		Monochrome image, Gray scale image	
Logo <logo>		Monochrome image, Gray scale image	

	Receipt	
	80 mm	58 mm
Barcode <barcode>	UPC-A, UPC-E, EAN13, JAN13, EAN8, JAN8, CODE39, ITF, CODABAR, CODE93, CODE128, GS1-128, GS1 DataBar Omnidirectional, GS1 DataBar Truncated, GS1 DataBar Limited, GS1 DataBar Expanded	
2D-Code <symbol>	PDF417, QR Code, MaxiCode, GS1 DataBar Stacked, GS1 DataBar Stacked Omnidirectional, GS1 DataBar Expanded Stacked, Composite Symbology	
Ruled Line <hline>, <vline-begin>, <vline-end>	Not supported	
Page Mode	Line <line> Rectangle <rectangle>	Not supported
Paper Cut <cut>	Cut, Feed cut	
Drawer Kick-Out <pulse>	Supported	
Buzzer <sound>	Not supported	
Paper Layout Settings <layout>	Not supported	
Command <command>	Supported	

TM-L90-i/ TM-L90

		Receipt	Die-cut Label
Resolution		203 dpi x 203 dpi (W x H)	
Print Width		256 dots (38 mm) to 576 dots (80 mm)	224 dots (38 mm) to 560 dots (80 mm)
Characters in a Line	Font A	ANK: 48 characters,	ANK: 46 characters
	Font B	ANK: 57 characters	ANK: 56 characters
	Font C	ANK: 72 characters	ANK: 70 characters
Character Size	Font A	ANK: 12 dots x 24 dots (W x H)	
	Font B	ANK: 10 dots x 24 dots (W x H)	
	Font C	ANK: 8 dots x 16 dots (W x H)	
Character Baseline	Font A	At the 21st dot from the top of the character	
	Font B	At the 21st dot from the top of the character	
	Font C	At the 15st dot from the top of the character	
Default Line Feed Space		30 dots	
Color Specification		First color Second color, Second color (when two-color printing is set)	
Page Mode Default Area		576 dots x 738 dots (W x H)	560 dots x 738 dots (W x H)
	when two-color printing is set	576 dots x 369 dots (W x H)	560 dots x 369 dots (W x H)
Page Mode Maximum Area		576 dots x 1476 dots (W x H)	560 dots x 1476 dots (W x H)
	when two-color printing is set	576 dots x 738 dots (W x H)	560 dots x 738 dots (W x H)
Raster Image <image>		Monochrome image, Two color image	
Logo <logo>		Monochrome image, Two color image (To perform two-color printing, change the settings of the printer using the memory switch setting utility.)	
Barcode <barcode>		UPC-A, UPC-E, EAN13, JAN13, EAN8, JAN8, CODE39, ITF, CODABAR, CODE93, CODE128	
2D-Code <symbol>		PDF417, QR Code, MaxiCode	
Ruled Line <hline>, <vline-begin>, <vline-end>		Not supported	

		Receipt	Die-cut Label
Page Mode	Line <line>	Not supported	
	Rectangle <rectangle>		
Paper Cut <cut>		Cut, Feed cut	
Drawer Kick-Out <pulse>		Supported	
Buzzer <sound>		Not supported	
Paper Layout Settings <layout>		Not supported (With automatic setup mode)	
Command <command>		Supported	

ePOS-Print Setting (TM-L90)

Item	Value
Printing Method	Thermal (203 dpi)
Character Code Tables	Page 0-5, 16-19

TM-P20

		58 mm
Resolution		203 dpi x 203 dpi (W x H)
Print Width		384 dots
Characters in a Line	Font A	ANK: 32 characters
	Font B	ANK: 42 characters
	Font C	ANK: 42 characters
	Font D	ANK: 38 characters
	Font E	ANK: 48 characters
Character Size	Font A	ANK: 12 dots x 24 dots (W x H)
	Font B	ANK: 9 dots x 24 dots (W x H)
	Font C	ANK: 9 dots x 17 dots (W x H)
	Font D	ANK: 10 dots x 24 dots (W x H)
	Font E	ANK: 8 dots x 16 dots (W x H)
Character Baseline	Font A	At the 21st dot from the top of the character
	Font B	At the 16th dot from the top of the character
	Font C	At the 16th dot from the top of the character
	Font D	At the 21st dot from the top of the character
	Font E	At the 15th dot from the top of the character
Default Line Feed Space		30 dots
Color Specification		First color
Page Mode Default Area		384 dots x 2400 dots (W x H)
Page Mode Maximum Area		384 dots x 2400 dots (W x H)
Raster Image <image>		Monochrome image
Logo <logo>		Monochrome image
Barcode <barcode>		UPC-A, UPC-E, EAN13, JAN13, EAN8, JAN8, CODE39, ITF, CODABAR, CODE93, CODE128, GS1-128, GS1 DataBar Omnidirectional, GS1 DataBar Truncated, GS1 DataBar Limited, GS1 DataBar Expanded
2D-Code <symbol>		PDF417, QR Code, MaxiCode, GS1 DataBar Stacked, GS1 DataBar Stacked Omnidirectional, GS1 DataBar Expanded Stacked, Composite Symbology
Ruled Line <hline>, <vline-begin>, <vline-end>		Not supported

		58 mm
Page Mode	Line <line>	Supported (Only solid line)
	Rectangle <rectangle>	
Paper Cut <cut>		Feeds paper to cutting position
Drawer Kick-Out <pulse>		Not supported
Buzzer <sound>		Supported
Paper Layout Settings <layout>		Supported
Command <command>		Supported

TM-P60II/ TM-P60II with Peeler

		Receipt	Die-cut label
Resolution		203 dpi x 203 dpi (W x H)	
Print Width		432 dots	160 dots ~ 400 dots
Characters in a Line	Font A	ANK: 36 characters	ANK: 33 characters
	Font B	ANK: 43 characters	ANK: 40 characters
	Font C	ANK: 54 characters	ANK: 50 characters
Character Size	Font A	ANK: 12 dots x 24 dots (W x H)	
	Font B	ANK: 10 dots x 24 dots (W x H)	
	Font C	ANK: 8 dots x 16 dots (W x H)	
Character Baseline	Font A	At the 21st dot from the top of the character	
	Font B	At the 21st dot from the top of the character	
	Font C	At the 15th dot from the top of the character	
Default Line Feed Space		30 dots	
Color Specification		First color	
Page Mode Default Area		432 dots x 1624 dots (W x H)	400 dots x 1624 dots (W x H)
Page Mode Maximum Area		432 dots x 1624 dots (W x H)	400 dots x 1624 dots (W x H)
Raster Image <image>		Monochrome image	
Logo <logo>		Monochrome image	
Barcode <barcode>		UPC-A, UPC-E, EAN13, JAN13, EAN8, JAN8, CODE39, ITF, CODABAR, CODE93, CODE128, GS1-128, GS1 DataBar Omnidirectional, GS1 DataBar Truncated, GS1 DataBar Limited, GS1 DataBar Expanded	
2D-Code <symbol>		PDF417, QR Code, MaxiCode, GS1 DataBar Stacked, GS1 DataBar Stacked Omnidirectional, GS1 DataBar Expanded Stacked, Aztec Code, DataMatrix (Composit Symbology : Not supported)	
Ruled Line <hline>, <vline-begin>, <vline-end>		Not supported	
Page Mode	Line <line>	Supported (Only solid line)	
	Rectangle <rectangle>		
Paper Cut <cut>		Feed cut (Feeds paper to cutting position)	
Drawer Kick-Out <pulse>		Not supported	
Buzzer <sound>		Support (Pattern 1 ~ Pattern 10, Stop)	

	Receipt	Die-cut label
Paper Layout Settings <layout>	Supported	
Command <command>	Supported	

Paper Layout

Paper type	Receipt paper (without black mark)	Receipt paper (with black mark)	Die-cut label paper (without black mark)	Die-cut label paper (with black mark)
width (sf)	290 to 600	290 to 600	290 to 600	290 to 600
height (sa)	0	0, 284 to 1550	0, 284 to 1550	0, 284 to 1550
margin_top (sb)	0	-130 to 1500	0 to 1500	-15 to 1500
margin_bottom (se)	0	0	-15 to 0	-15 to 15
offset_cut (sc)	0	-256 to 50	0 to 50	0 to 50
offset_label (sd)	0	0	0	0 to 15

TM-P80

		80 mm
Resolution		203 dpi x 203 dpi (W x H)
Print Width		576 dots
Characters in a Line	Font A	ANK: 48 characters
	Font B	ANK: 64 characters
Character Size	Font A	ANK: 12 dots x 24 dots (W x H)
	Font B	ANK: 9 dots x 17 dots (W x H)
Character Baseline	Font A	At the 21st dot from the top of the character
	Font B	At the 16th dot from the top of the character
Default Line Feed Space		30 dots
Color Specification		First color
Page Mode Default Area		576 dots x 1662 dots (W x H)
Page Mode Maximum Area		576 dots x 1662 dots (W x H)
Raster Image <image>		Monochrome image
Logo <logo>		Monochrome image
Barcode <barcode>		UPC-A, UPC-E, EAN13, JAN13, EAN8, JAN8, CODE39, ITF, CODABAR, CODE93, CODE128, GS1-128, GS1 DataBar Omnidirectional, GS1 DataBar Truncated, GS1 DataBar Limited, GS1 Databar Expanded
2D-Code <symbol>		PDF417, QR Code, MaxiCode, Data Matrix, Aztec Code, GS1 DataBar Stacked, GS1 DataBar Stacked Omnidirectional, GS1 DataBar Expanded Stacked, Composite Symbology
Ruled Line <hline>, <vline-begin>, <vline-end>		Not supported
Page Mode	Line <line>	Not supported
	Rectangle <rectangle>	
Paper Cut <cut>		Feed
Drawer Kick-Out <pulse>		Not supported
Buzzer <sound>		Supported
Paper Layout Settings <layout>		Supported
Command <command>		Supported

Paper Layout

Paper type	Receipt paper (without black mark)	Receipt paper (with black mark)
width (sf)	800	800
height (sa)	0	0, 284 to 3100
margin_top (sb)	0	-98 to 3100
margin_bottom (se)	0	0
offset_cut (sc)	0	-173 to 50
offset_label (sd)	0	0

TM-T20

		58 mm	80 mm
Resolution		203 dpi x 203 dpi (W x H)	
Print Width		420 dots	576 dots
Characters in a Line	Font A	ANK: 35 characters,	ANK: 48 characters
	Font B	ANK: 46 characters	ANK: 64 characters
Character Size	Font A	ANK: 12 dots x 24 dots (W x H)	
	Font B	ANK: 9 dots x 17 dots (W x H)	
Character Baseline	Font A	At the 21st dot from the top of the character	
	Font B	At the 16th dot from the top of the character	
Default Line Feed Space		30 dots	
Color Specification		First color	
Page Mode Default Area		420 dots x 831 dots (W x H)	576 dots x 831 dots (W x H)
Page Mode Maximum Area		420 dots x 1662 dots (W x H)	576 dots x 1662 dots (W x H)
Raster Image <image>		Monochrome image	
Logo <logo>		Monochrome image	
Barcode <barcode>		UPC-A, UPC-E, EAN13, JAN13, EAN8, JAN8, CODE39, ITF, CODABAR, CODE93, CODE128, GS1-128, GS1 DataBar Omnidirectional, GS1 DataBar Truncated, GS1 DataBar Limited, GS1 DataBar Expanded	
2D-Code <symbol>		PDF417, QR Code, MaxiCode, GS1 DataBar Stacked, GS1 DataBar Stacked Omnidirectional, GS1 DataBar Expanded Stacked (Composit Symbology : Not supported)	
Ruled Line <hline>, <vline-begin>, <vline-end>		Not supported	
Page Mode	Line <line>	Not supported	
	Rectangle <rectangle>		
Paper Cut <cut>		Cut, Feed cut	
Drawer Kick-Out <pulse>		Supported	
Buzzer <sound>		Supported (Pattern A ~ Pattern E, Error, No paper, Stop)	
Paper Layout Settings <layout>		Not supported	
Command <command>		Supported	

TM-T20II-i/ TM-T20II

	58 mm	80 mm
Resolution	203 dpi x 203 dpi (W x H)	
Print Width (42 Column Mode)	420 dots (378 dots)	576 dots (546 dots)
Characters in a Line Font A (42 Column Mode)	ANK: 35 characters (ANK: 42 characters)	ANK: 48 characters (ANK: 42 characters)
	Font B (42 Column Mode)	ANK: 46 characters (ANK: 31 characters)
Character Size Font A (42 Column Mode)	ANK: 12 dots x 24 dots (W x H)	
	(ANK: 9 dots x 17 dots)	(ANK: 13 dots x 24 dots)
Font B (42 Column Mode)	ANK: 9 dots x 17 dots (W x H)	
	(ANK: 12 dots x 24 dots)	(ANK: 9 dots x 17 dots)
Character Baseline Font A	At the 21st dot from the top of the character	
	Font B	At the 16th dot from the top of the character
Default Line Feed Space	30 dots	
Color Specification	First color	
Page Mode Default Area	420 dots x 831 dots (W x H)	576 dots x 831 dots (W x H)
Page Mode Maximum Area	420 dots x 1662 dots (W x H)	576 dots x 1662 dots (W x H)
Raster Image <image>	Monochrome image	
Logo <logo>	Monochrome image	
Barcode <barcode>	UPC-A, UPC-E, EAN13, JAN13, EAN8, JAN8, CODE39, ITF, CODABAR, CODE93, CODE128, GS1-128, GS1 DataBar Omnidirectional, GS1 DataBar Truncated, GS1 DataBar Limited, GS1 Databar Expanded	
2D-Code <symbol>	PDF417, QR Code, MaxiCode, GS1 DataBar Stacked, GS1 DataBar Stacked Omnidirectional, GS1 DataBar Expanded Stacked, Composite Symbology	
Ruled Line <hline>, <vline-begin>, <vline-end>	Not supported	
Page Mode Line <line>	Not supported	
	Rectangle <rectangle>	
Paper Cut <cut>	Cut, Feed cut	
Drawer Kick-Out <pulse>	Supported	

	58 mm	80 mm
Buzzer <sound>	Supported	
Paper Layout Settings <layout>	Not supported	
Command <command>	Supported	

ePOS-Print Setting (TM-T20II)

Item	Value
Printing Method	Thermal (203 dpi)
Character Code Tables	Page 0-5, 16-19, 20-21, 26,30-31, 11-15, 32-53

TM-T70-i/ TM-T70

		58 mm	80 mm
Resolution		203 dpi x 203 dpi (W x H)	
Print Width		420 dots	576 dots
Characters in a Line	Font A	ANK: 34 characters	ANK: 48 characters
	Font B	ANK: 46 characters	ANK: 64 characters
Character Size	Font A	ANK: 12 dots x 24 dots (W x H)	
	Font B	ANK: 8 dots x 16 dots (W x H)	
Character Baseline	Font A	At the 21st dot from the top of the character	
	Font B	At the 15th dot from the top of the character	
Default Line Feed Space		30 dots	
Color Specification		First color	
Page Mode Default Area		576 dots x 1662 dots (W x H)	
Page Mode Maximum Area		576 dots x 1662 dots (W x H)	
Raster Image <image>		Monochrome image	
Logo <logo>		Monochrome image	
Barcode <barcode>		UPC-A, UPC-E, EAN13, JAN13, EAN8, JAN8, CODE39, ITF, CODABAR, CODE93, CODE128	
2D-Code <symbol>		PDF417, QR Code	
Ruled Line <hline>, <vline-begin>, <vline-end>		Not supported	
Page Mode	Line <line>	Not supported	
	Rectangle <rectangle>		
Paper Cut <cut>		Cut, Feed cut	
Drawer Kick-Out <pulse>		Supported	
Buzzer <sound>		Not supported	
Paper Layout Settings <layout>		Not supported	
Command <command>		Supported	

ePOS-Print Setting (TM-T70)

Item	Value
Printing Method	Thermal (180 dpi)
Character Code Tables	Page 0-5, 16-19

TM-T70-i/ TM-T70 (Multi-language model)

		80 mm
Resolution		203 dpi x 203 dpi (W x H)
Print Width		576 dots
Characters in a Line	Font A	ANK: 48 characters
	Font B	ANK: 64 characters
Character Size	Font A	ANK: 12 dots x 24 dots (W x H)
	Font B	ANK: 9 dots x 17 dots (W x H)
Character Baseline	Font A	At the 21st dot from the top of the character
	Font B	At the 16th dot from the top of the character
Default Line Feed Space		30 dots
Color Specification		First color
Page Mode Default Area		576 dots x 1662 dots (W x H)
Page Mode Maximum Area		576 dots x 1662 dots (W x H)
Raster Image <image>		Monochrome image
Logo <logo>		Monochrome image
Barcode <barcode>		UPC-A, UPC-E, EAN13, JAN13, EAN8, JAN8, CODE39, ITF, CODABAR, CODE93, CODE128
2D-Code <symbol>		PDF417, QR Code
Ruled Line <hline>, <vline-begin>, <vline-end>		Not supported
Page Mode	Line <line>	Not supported
	Rectangle <rectangle>	
Paper Cut <cut>		Cut, Feed cut
Drawer Kick-Out <pulse>		Supported
Buzzer <sound>		Not supported
Paper Layout Settings <layout>		Not supported
Command <command>		Supported

ePOS-Print Setting (TM-T70)

Item	Value
Printing Method	Thermal (203 dpi)
Character Code Tables	Page 0-5, 16-19

TM-T70II-DT/ TM-T70II

		80 mm
Resolution		203 dpi x 203 dpi (W x H)
Print Width		576 dots
Characters in a Line	Font A	ANK: 48 characters
	Font B	ANK: 72 characters
Character Size	Font A	ANK: 12 dots x 24 dots (W x H)
	Font B	ANK: 9 dots x 17 dots (W x H)
Character Baseline	Font A	At the 21st dot from the top of the character
	Font B	At the 15th dot from the top of the character
Default Line Feed Space		30 dots
Color Specification		First color
Page Mode Default Area		576 dots x 1662 dots (W x H)
Page Mode Maximum Area		576 dots x 1662 dots (W x H)
Raster Image <image>		Monochrome image
Logo <logo>		Monochrome image
Barcode <barcode>		UPC-A, UPC-E, EAN13, JAN13, EAN8, JAN8, CODE39, ITF, CODABAR, CODE93, CODE128, GS1-128, GS1 DataBar Omnidirectional, GS1 DataBar Truncated, GS1 DataBar Limited, GS1 Databar Expanded
2D-Code <symbol>		PDF417, QR Code, MaxiCode, GS1 DataBar Stacked, GS1 DataBar Stacked Omnidirectional, GS1 DataBar Expanded Stacked
Ruled Line <hline>, <vline-begin>, <vline-end>		Not supported
Page Mode	Line <line>	Not supported
	Rectangle <rectangle>	
Paper Cut <cut>		Cut, Feed cut
Drawer Kick-Out <pulse>		Supported
Buzzer <sound>		Supported
Paper Layout Settings <layout>		Not supported
Command <command>		Supported

ePOS-Print Setting

Item	Value
Printing Method	Thermal (203 dpi)
Character Code Tables	Page 0-5, 16-19, 20-21, 26,30-31, 11-15, 32-53

TM-T82II-i/ TM-T82II

	80 mm	
Resolution	203 dpi x 203 dpi (W x H)	
Print Width (42 Column Mode)	576 dots (546 dots)	
Characters in a Line (42 Column Mode)	Font A	ANK: 48 characters
	Font B	ANK: 64 characters
Character Size (42 Column Mode)	Font A	ANK: 12 dots x 24 dots (W x H)
	Font B	ANK: 9 dots x 17 dots (W x H)
Character Baseline	Font A	At the 21st dot from the top of the character
	Font B	At the 16th dot from the top of the character
Default Line Feed Space	30 dots	
Color Specification	First color	
Page Mode Default Area	576 dots x 831 dots (W x H)	
Page Mode Maximum Area	576 dots x 1662 dots (W x H)	
Raster Image <image>	Monochrome image	
Logo <logo>	Monochrome image	
Barcode <barcode>	UPC-A, UPC-E, EAN13, JAN13, EAN8, JAN8, CODE39, ITF, CODABAR, CODE93, CODE128, GS1-128, GS1 DataBar Omnidirectional, GS1 DataBar Truncated, GS1 DataBar Limited, GS1 Databar Expanded	
2D-Code <symbol>	PDF417, QR Code, MaxiCode, GS1 DataBar Stacked, GS1 DataBar Stacked Omnidirectional, GS1 DataBar Expanded Stacked, Composite Symbology	
Ruled Line <hline>, <vline-begin>, <vline-end>	Not supported	
Page Mode	Line <line> Rectangle <rectangle>	Not supported
Paper Cut <cut>	Cut, Feed cut	
Drawer Kick-Out <pulse>	Supported	

	80 mm
Buzzer <sound>	Supported
Paper Layout Settings <layout>	Not supported
Command <command>	Supported

TM-T83II-i/ TM-T83II

		80 mm
Resolution		180 dpi x 180 dpi (W x H)
Print Width		512 dots
Characters in a Line	Font A	ANK: 42 characters Kanji: 21 characters
	Font B	ANK: 56 characters Kanji: 32 characters
Character Size	Font A	ANK: 12 dots x 24 dots (W x H) Kanji: 24 dots x 24 dots (W x H)
	Font B	ANK: 9 dots x 17 dots (W x H) Kanji: 16 dots x 16 dots (W x H)
Character Baseline	Font A	ANK: At the 21st dot from the top of the character Kanji: At the 21st dot from the top of the character
	Font B	ANK: At the 16th dot from the top of the character Kanji: At the 15th dot from the top of the character
Default Line Feed Space		30 dots
Color Specification		First color
Page Mode Default Area		512 dots x 1662 dots (W x H)
Page Mode Maximum Area		512 dots x 1662 dots (W x H)
Raster Image <image>		Monochrome image
Logo <logo>		Monochrome image
Barcode <barcode>		UPC-A, UPC-E, EAN13, JAN13, EAN8, JAN8, CODE39, ITF, CODABAR, CODE93, CODE128, GS1-128, GS1 DataBar Omnidirectional, GS1 DataBar Truncated, GS1 DataBar Limited, GS1 DataBar Expanded
2D-Code <symbol>		PDF417, QR Code, MaxiCode, GS1 DataBar Stacked, GS1 DataBar Stacked Omnidirectional, GS1 DataBar Expanded Stacked
Ruled Line <hline>, <vline-begin>, <vline-end>		Not supported
Page Mode	Line <line>	Not supported
	Rectangle <rectangle>	
Paper Cut <cut>		Cut, Feed cut
Drawer Kick-Out <pulse>		Supported

	80 mm
Buzzer <sound>	Supported
Paper Layout Settings <layout>	Not supported
Command <command>	Supported

TM-T88IV

		80 mm	58 mm
Resolution		180 dpi x 180 dpi (W x H)	
Print Width		512 dots	360 dots
Characters in a Line	Font A	ANK: 42 characters	ANK: 30 characters
	Font B	ANK: 56 characters	ANK: 40 characters
Character Size	Font A	ANK: 12 dots x 24 dots (W x H)	
	Font B	ANK: 9 dots x 17 dots (W x H)	
Character Baseline	Font A	At the 21st dot from the top of the character	
	Font B	At the 16th dot from the top of the character	
Default Line Feed Space		30 dots	
Color Specification		First color First color, Second color (when two-color printing is set)	
Page Mode Default Area		512 dots x 831 dots (W x H)	360 dots x 831 dots (W x H)
	when two-color printing is set	512 dots x 415 dots (W x H)	360 dots x 415 dots (W x H)
Page Mode Maximum Area		512 dots x 1662 dots (W x H)	360 dots x 1662 dots (W x H)
	when two-color printing is set	512 dots x 831 dots (W x H)	360 dots x 831 dots (W x H)
Raster Image <image>		Monochrome image, two-color image	
Logo <logo>		Monochrome image, two-color image (To perform two-color printing, change the settings of the printer using the memory switch setting utility.)	
Bar Code		UPC-A, UPC-E, EAN13, JAN13, EAN8, JAN8, CODE39, ITF, CODABAR, CODE93, CODE128, GS1-128	
2D-Code <symbol>		PDF417, QR Code	
Ruled Line <hline>, <vline-begin>, <vline-end>		Not supported	
Page Mode	Line <line>	Not supported	
	Rectangle <rectangle>		
Paper Cut <cut>		Cut, Feed cut	
Drawer Kick-Out <pulse>		Supported	
Buzzer <sound>		Not supported	
Paper Layout Settings <layout>		Not supported	

	80 mm	58 mm
Command <command>	Supported	

ePOS-Print Setting

Item	Value
Printing Method	Thermal (180 dpi)
Character Code Tables	Page 0-5, 16-19

TM-T88V-DT/ TM-T88V-i/ TM-T88V

* Only for South Asia model

		58 mm	80 mm
Resolution		180 dpi x 180 dpi (W x H)	
Print Width		360 dots	512 dots
Characters in a Line	Font A	ANK: 30 characters	ANK: 42 characters
	Font B	ANK: 40 characters	ANK: 56 characters
	Special font A*	30 characters	42 characters
	Special font B*	40 characters	56 characters
Character Size	Font A	ANK: 12 dots x 24 dots (W x H)	
	Font B	ANK: 9 dots x 17 dots (W x H)	
	Special font A*	12 dots x 24 dots (W x H)	
	Special font B*	9 dots x 24 dots (W x H)	
Character Baseline	Font A	At the 21st dot from the top of the character	
	Font B	At the 16th dot from the top of the character	
	Special font A*	At the 20th dot from the top of the character	
	Special font B*	At the 20th dot from the top of the character	
Default Line Feed Space		30 dots	
Color Specification		First color	
Page Mode Default Area		360 dots x 831 dots (W x H)	512 dots x 831 dots (W x H)
Page Mode Maximum Area		360 dots x 1662 dots (W x H)	512 dots x 1662 dots (W x H)
Raster Image <image>		Monochrome image, Gray scale image	
Logo <logo>		Monochrome image, Gray scale image	
Barcode <barcode>		UPC-A, UPC-E, EAN13, JAN13, EAN8, JAN8, CODE39, ITF, CODABAR, CODE93, CODE128, GS1-128, GS1 DataBar Omnidirectional, GS1 DataBar Truncated, GS1 DataBar Limited, GS1 Databar Expanded	
2D-Code <symbol>		PDF417, QR Code, MaxiCode, GS1 DataBar Stacked, GS1 DataBar Stacked Omnidirectional, GS1 DataBar Expanded Stacked (Composite Symbology not supported)	

* Only for South Asia model

	58 mm	80 mm
Ruled Line <hline>, <vline-begin>, <vline-end>	Not supported	
Page Mode	Line <line> Rectangle <rectangle>	Not supported
Paper Cut <cut>	Cut, Feed cut	
Drawer Kick-Out <pulse>	Supported	
Buzzer <sound>	Supported	
Paper Layout Settings <layout>	Not supported	
Command <command>	Supported	

ePOS-Print Setting (TM-T88V)

Item	Value
Printing Method	Thermal (180 dpi)
Character Code Tables	Page 0-5, 16-19, 20-21, 26,30-31, 11-15, 32-53

TM-T90

		58 mm	60 mm	80 mm
Resolution		180 dpi x 180 dpi (W x H)		
Print Width		360 dots	384 dots	512 dots
Characters in a Line	Font A	ANK: 30 characters,	ANK: 32 characters	ANK: 42 characters
	Font B	ANK: 40 characters	ANK: 42 characters	ANK: 56 characters
	Font C	ANK: 52 characters	ANK: 54 characters	ANK: 72 characters
Character Size	Font A	ANK: 12 dots x 24 dots (W x H)		
	Font B	ANK: 9 dots x 17 dots (W x H)		
	Font C	ANK: 8 dots x 16 dots (W x H)		
Character Baseline	Font A	At the 21st dot from the top of the character		
	Font B	At the 16th dot from the top of the character		
	Font C	At the 15th dot from the top of the character		
Default Line Feed Space		30 dots		
Color Specification		First color Second color, Second color (when two-color printing is set)		
Page Mode Default Area		360 dots x 831 dots (W x H)	384 dots x 831 dots (W x H)	512 dots x 831 dots (W x H)
	when two-color printing is set	360 dots x 415 dots (W x H)	384 dots x 415 dots (W x H)	512 dots x 415 dots (W x H)
Page Mode Maximum Area		360 dots x 1662 dots (W x H)	384 dots x 1662 dots (W x H)	512 dots x 1662 dots (W x H)
	when two-color printing is set	360 dots x 831 dots (W x H)	384 dots x 831 dots (W x H)	512 dots x 831 dots (W x H)
Raster Image <image>		Monochrome image, Two color image		
Logo <logo>		Monochrome image, Two color image (To perform two-color printing, change the settings of the printer using the memory switch setting utility.)		
Barcode <barcode>		UPC-A, UPC-E, EAN13, JAN13, EAN8, JAN8, CODE39, ITF, CODABAR, CODE93, CODE128		
2D-Code <symbol>		PDF417		

	58 mm	60 mm	80 mm
Ruled Line <hline>, <vline-begin>, <vline-end>	Not supported		
Page Mode	Line <line> Rectangle <rectangle>	Not supported	
Paper Cut <cut>	Cut, Feed cut		
Drawer Kick-Out <pulse>	Supported		
Buzzer <sound>	Not supported		
Paper Layout Settings <layout>	Not supported		
Command <command>	Supported		

ePOS-Print Setting

Item	Value
Printing Method	Thermal (180 dpi)
Character Code Tables	Page 0-5, 16-19

TM-U220-i/ TM-U220

		76 mm	70 mm	58 mm
Resolution		80 dpi x 72 dpi (W x H)		
Print Width		200 dots	180 dots	150 dots
Characters in a Line	Font A	ANK: 33 characters,	ANK: 30 characters	ANK: 25 characters
	Font B	ANK: 40 characters	ANK: 36 characters	ANK: 30 characters
Character Size	Font A	ANK: 4.5 dots x 9 dots (W x H)		
	Font B	ANK: 3.5 dots x 9 dots (W x H)		
Character Baseline	Font A	Bottom of the characters		
	Font B	Bottom of the characters		
Default Line Feed Space		12 dots		
Color Specification		First color First color, Second color (When using a two-color ribbon cassette)		
Page Mode Default Area		Not supported		
Page Mode Maximum Area		Not supported		
Raster Image <image>		Monochrome image		
Logo <logo>		Not supported		
Barcode <barcode>		Not supported		
2D-Code <symbol>		Not supported		
Ruled Line <hline>, <vline-begin>, <vline-end>		Not supported		
Page Mode	Line <line>	Not supported		
	Rectangle <rectangle>			
Paper Cut <cut>		Cut, Feed cut		
Drawer Kick-Out <pulse>		Supported		
Buzzer <sound>		Not supported		
Paper Layout Settings <layout>		Not supported		
Command <command>		Supported		



Appendix

ePOS-Print Editor

This section describes how to use ePOS-Print Editor included in the contents in the package.

This tool is a support tool for generating XML data. This tool allows you to create an ePOS-Print XML (p. 61) print document as you like. In addition, the generated XML data can be printed for testing. Use this tool for your application development.

ePOS-Print Editor Operating Environment

- Web Browser
 - Windows Internet Explorer 9 or later
 - Mozilla Firefox 13 or later
 - Google Chrome 19 or later
 - Apple Safari 5.1.7 or later
 - iPad Safari in iOS 5.1 or later

Environment Setting Procedure



- In Google Chrome, when a preview image including pictures is displayed, a "SECURITY_ERR: DOM Exception 18" error occurs.
- In Windows Internet Explorer 9, when printing is performed, a "SCRIPT5: Access is denied." error occurs.



If opening a page with ePOS-Print Editor's HTML file placed on the local disk, some functionality does not operate due to your Web browser's security policy. Place the HTML file of ePOS Editor to a folder under Web server.

- 1** Copy the editor folder contained in the sample program to the Web server.
- 2** Open the following URL page using the Web browser.
[http://\(Web server IP address\)/editor/index.html](http://(Web server IP address)/editor/index.html)

3 ePOS-Print Editor appears.

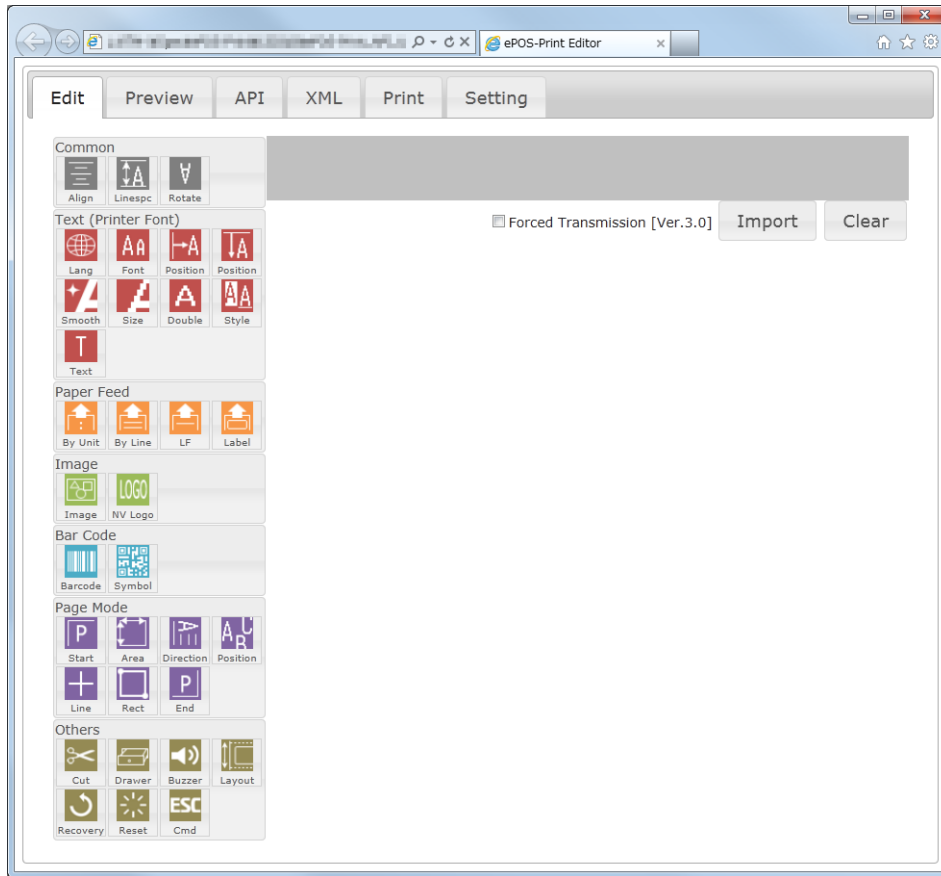

Setting

Perform the print setting and the preview setting. Select the (Setting) tab to display the Setting screen.

Item	Description
Model	Specify the model of the printer to be used for printing. The Preview screen resizes according to the paper width set to the model.
IP address of ePOS-Print supported TM printer	Specify the IP address of the printer. Be sure to specify this item.
Device ID of the target printer	Specify the device ID of the printer. Be sure to specify this item.
Print timeout (milliseconds)	Specify the print timeout time in milliseconds. The maximum value is 60000 (60 seconds).
Monitor the status	When this checkbox is checked, the printer's status is monitored.
Use print job ID	Check this for a print job ID to be assigned when printing.

Creating a Sample Code

Select the (Edit) tab to display the Edit screen. Create an ePOS-Print XML print document in the Edit screen.

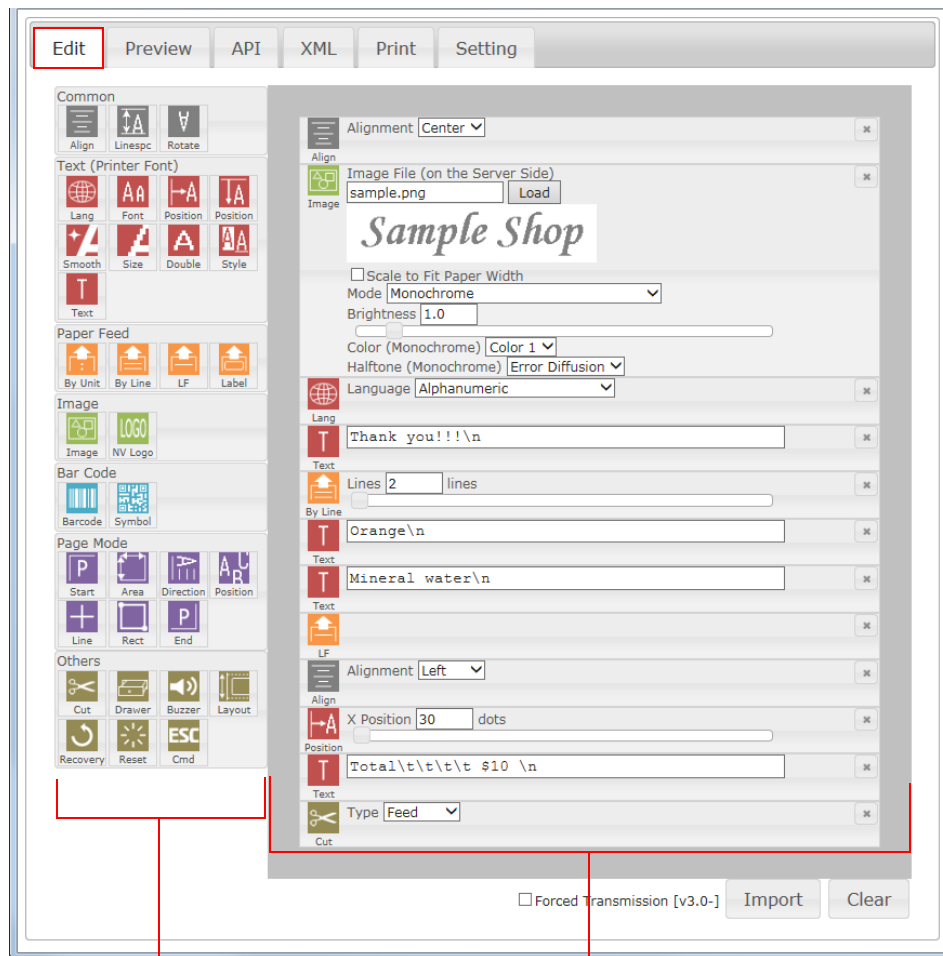

Menu area

Edit area

Item	Description
Menu area	Displays the available functions. Click an icon to add it to the bottom of the edit area, and drag an icon to insert it anywhere in the edit area.
Edit area	Displays the functions selected in the menu area. Drag an element to change its position. An element can be deleted using the x button located on its right side.
Import	ePOS-Print Editor can import an ePOS-Print XML print document. For details, refer to Import (p.144) .
Clear	Deletes the edited details.
Forced Transmission	Sets forced transmission mode.

Create XML data as follows:

- 1** Click an icon in the menu area to add an element in the edit area.
The position of the added function can be changed by dragging.
- 2** Configure the added element.
Example: When the NV logo is added, set the key code.
- 3** Select the (Preview) tab to check the preview image.
When a printer is connected, you can also check the image by printing.
For details, refer to [Print \(p.143\)](#).



- Logo printing, barcode printing, 2D code printing, ESC command, buzzer sound, drawer kick, and paper cut are displayed as icons.
- The layout may change depending on the preview settings.
(For details, refer to [Setting \(p.139\)](#)).

- 4 Select the (XML) tab. The ePOS-Print XML document is displayed. Use it by copying. Save the ePOS-Print XML print document, and you can edit it by importing it again.

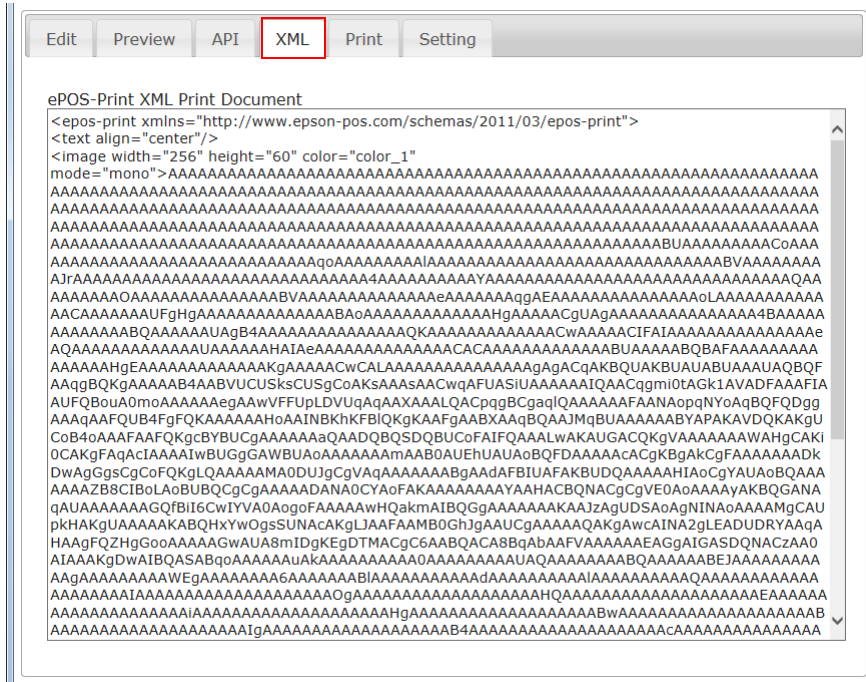

Print

Using the printer, print the ePOS-Print XML print document according to the printer's settings to perform test printing.

(For details on the printer settings, refer to [Setting \(p.139\)](#)).

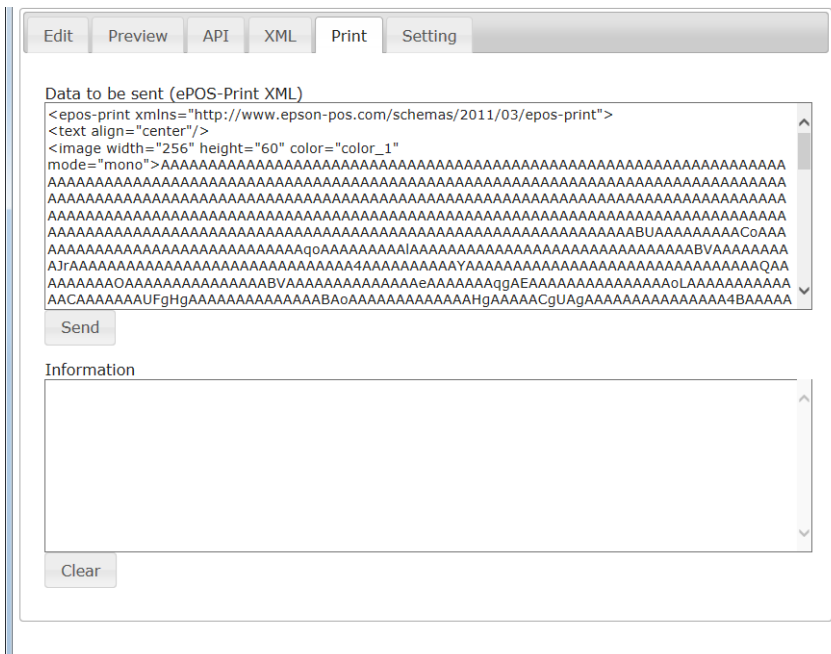

Item	Description
Data to be sent (ePOS-Print XML)	The ePOS-Print XML document is displayed.
Send	Sends data to the printer and performs printing.
Information	Displays the print status.
Clear	Deletes the content in the (Information) box.

Perform printing as follows:

- Select the (Print) tab.
- Check the content in the (Data to be sent (ePOS-Print XML)) box and press the (Send) button.
The ePOS-Print XML print document created using the Edit tab page is displayed in "Data to be sent (ePOS-Print XML)".
- The print document is printed to ePOS-Print supported TM printer.
The acquired status is displayed in the Information box.

Import

ePOS-Print Editor can import an ePOS-Print XML print document.

This function is used to edit the already created ePOS-Print XML print document.

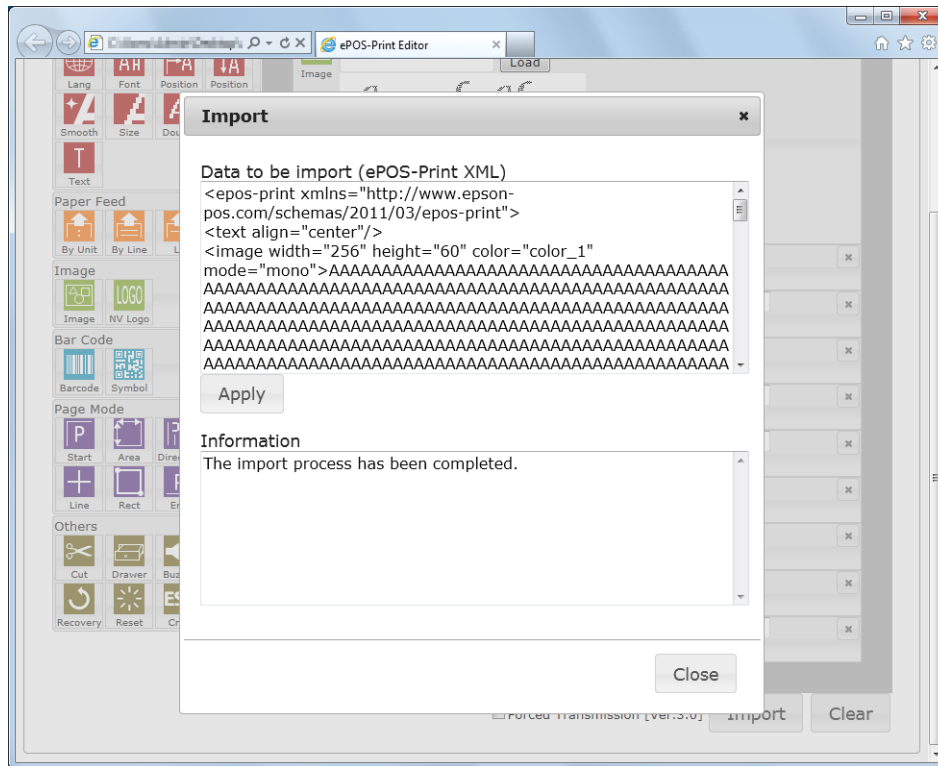

Item	Description
Data to be import (ePOS-Print XML)	Pastes the ePOS-Print XML print document.
Apply	Imports the ePOS-Print XML print document.
Information	Displays the import information.
Close	Closes the Import screen.

ePOS-Print Editor can import an ePOS-Print XML print document as follows:

- 1** Select the (Edit) tab and click the (Import) button.
- 2** The "Import" screen appears. Paste the ePOS-Print XML print document in the (Data to be import (ePOS-Print XML)) box.
- 3** Click the (Apply) button.
- 4** The "Confirmation" screen appears. Click the (Yes) button.

Encoding Graphic Data

Use ePOS-Print Editor to convert raster graphic bit-image data into a base 64 encoded character string.

How to Use ePOS-Print Editor

Create data as follows:

- 1 Store the image file you want to print into the same level as the index of this tool.
- 2 Start ePOS-Print Editor.
- 3 Select the (Image) icon in the menu area and add it in the edit area.

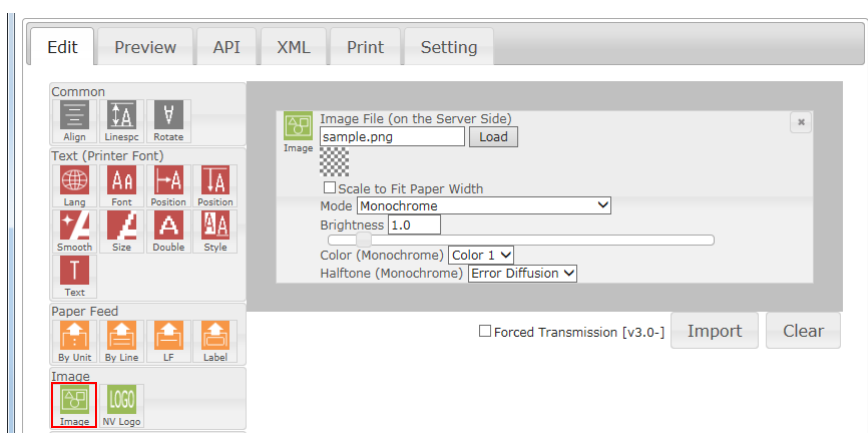

- 4 Specify the name of the stored image file for "Image File (on the Server Side)" and click the (Load) button.
- 5 Specify values as needed for "Scale to Fit Paper Width", "Mode", "Brightness", "Color", and "Halftone".

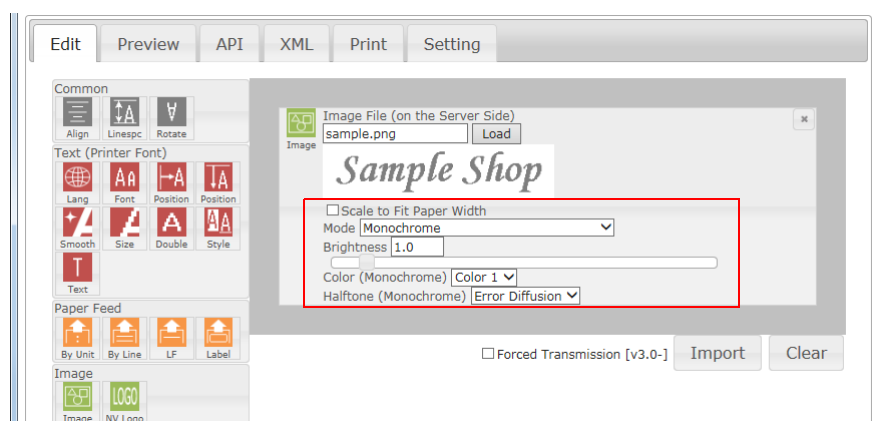

6 Select the (XML) tab.

7 Code converted into a base 64 encoded character string is displayed in (ePOS-Print XML Print Document). Copy the desired character string for use.

