



AI-6800 CCD Scanner User Guide



<http://www.argox.com>
service@argox.com

Version: V1.9
Date: March. 27, 2020

Revision History

Changes to the user manual are listed below:

Version	Date (Y/M/D)	Description	Page #
1.0	2016/1/14	Initial release	
2.0	2020/3/27	Delete the AI-6800L model from the manual	(All)

Regulatory Compliance

FEDERAL COMMUNICATIONS COMMISSION INTERFERENCE STATEMENT

This equipment has been tested and found to comply with the limits for a Class B digital device, pursuant to part 15 of the FCC Rules. These limits are designed to provide reasonable protection against harmful interference in a residential installation. This equipment generates, uses and can radiate radio frequency energy and, if not installed and used in accordance with the instructions, may cause harmful interference to radio communications. However, there is no guarantee that interference will not occur in a particular installation. If this equipment does cause harmful interference to radio or television reception, which can be determined by turning the equipment off and on, the user is encouraged to try to correct the interference by one or more of the following measures:

- Reorient or relocate the receiving antenna.

- Increase the separation between the equipment and receiver.

- Connect the equipment into an outlet on a circuit different from that to which the receiver is connected.

- Consult the dealer or an experienced radio/ TV technician for help.

CAUTION:

Any changes or modifications not expressly approved by the grantee of this device could void the user's authority to operate the equipment.

RF exposure warning

The equipment complies with FCC RF exposure limits set forth for an uncontrolled environment.

The equipment must not be co-located or operating in conjunction with any other antenna or transmitter.

RF EXPOSURE WARNING:

The equipment complies with FCC RF exposure limits set forth for an uncontrolled environment.

The equipment must not be co-located or operating in conjunction with any other antenna or transmitter.



Note All brands and trademarks shall belong to their respective owner.



Note Specification is subject to changes without notice.

Contents

1	Introduction	1
1.1	Unpacking	1
1.2	Understand your scanner	3
1.2.1	Scanner	3
1.2.2	Stand(optional accessory).....	4
1.3	Indicators.....	5
1.3.1	Status lights.....	5
1.3.2	Status sound	5
1.3.3	Vibration	5
2	Get started	6
2.1	Installation.....	6
2.1.1	Set up your scanner	6
2.1.2	How to scan	7
2.1.3	Work with the ASCII table	7
2.2	Unplug cable	8
3	Controls and settings.....	9
3.1	Interface selection.....	12
3.1.1	USB HID key board	13
3.1.2	RS-232.....	16
3.2	Scan properties	19
3.3	Indicator	24
3.4	Characters and strings (transmission)	26
3.4.1	Prefix and suffix	26
3.4.2	Preamble and postamble.....	27
3.4.3	String groups.....	29
	Example	29
3.4.4	ID, name and capitalization	33
3.5	Scanner information.....	35
3.5.1	Parameters.....	35

3.5.2	Data Magic settings	36
3.5.3	Firmware version	36
3.6	Reset your scanner	37
3.7	Update firmware	38
	Install driver	46
3.8	Data Magic	48
	Data Magic commands	49
3.8.1	Bar code scanning	52
	Data format.....	52
	Bar codes	55
	Example	57
	Scan Utility	62
	Virtual COM	66
4	Bar codes	68
	UPC-A	68
	UPC-E.....	72
	EAN-13	75
	EAN-8	78
	Code 39	82
	Interleaved 2 of 5	86
	Industrial 2 of 5	88
	Matrix 2 of 5.....	90
	Codabar	92
	Code 128 / GS1-128	95
	Code 93	99
	Code 11	101
	MSI/Plessey	103
	UK/Plessey	105
	Telepen.....	107
	Standard 2 of 5.....	109
	China Post	111

Italian Pharmacode (Code 32).....	113
Code 16K	115
EAN UCC Composite.....	117
GS1 Databar Omnidirectional	119
GS1 Databar Limited	121
GS1 Databar Expanded.....	123
5 Troubleshooting	125
5.1 Scanner issues	125
5.2 Bar code issues.....	125
6 Specifications	127
6.1 Pin Assignments	129
Appendix A. Test symbologies	130
Appendix B. ASCII table	133
Appendix C. Default settings of bar codes.....	134
Appendix D. Data entry bar codes	136

1 Introduction

AI-6800 is a cord scanner that can read bar codes on objects or on screens. The high performance scanning engine delivers high speed and high readability, making it an ideal scanning solution for business.

- **High decoding performance** Fast and easy scan for 1D bar codes.
- **Water resistant and dust-tight** With the IP65 rating, AI-6800 can be used in various environment without being damaged by water and dust.

1.1 Unpacking

Make sure all of the following items are included in your package.

Scanner

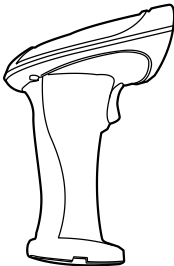

Quick Start Guide

Quick Start Guide

USB Cable

or

RS-232 Cable

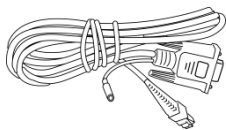
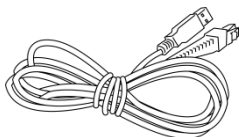

Plug and Power Supply

Stand

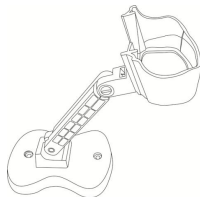
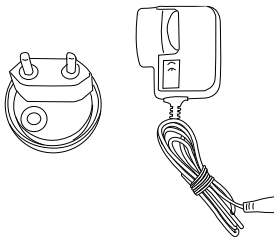

Power supply is optional accessory for RS-232 packs.

Stand is optional accessory

When you receive your scanner, open the package immediately and inspect for shipping damage. If you discover any damage, contact the shipping company and file a claim. Argox is not responsible for any damage incurred during shipping. Save all package materials for the shipping company to inspect.



Note If any item is missing, please contact your local dealer.

1.2 Understand your scanner

1.2.1 Scanner

■ Perspective

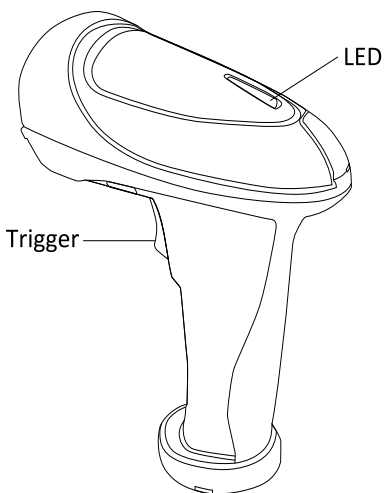

■ Bottom

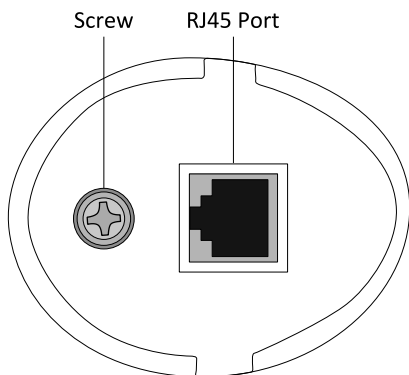

1.2.2 Stand(optional accessory)

■ Right side

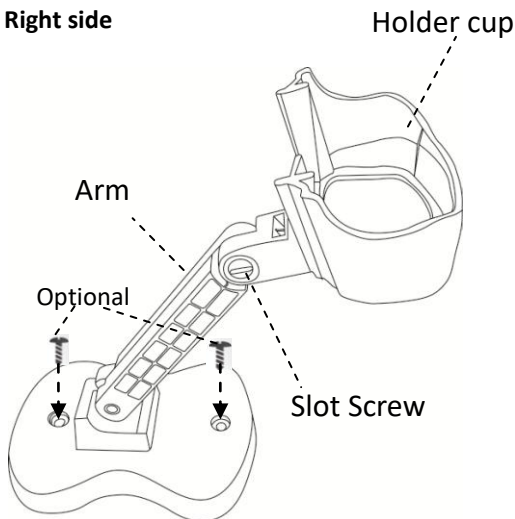

■ Left side

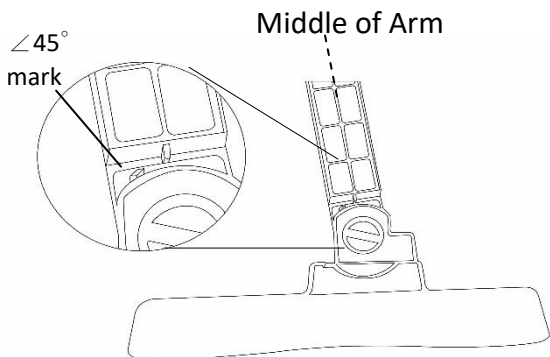

Attention : If middle of arm below $\angle 45^\circ$ mark, Use the optional screw to hold the bottom of stand.

1.3 Indicators

1.3.1 Status lights

Status lights (LED) are helpful for checking your scanner's status. The table below shows the LED behavior and the status it indicates.

Status	Scanner LED
Good Read	Green
Firmware Update	Flash green

1.3.2 Status sound

In addition to status lights, your scanner makes sounds to indicate the status it is in.

Status	Scanner Sound
Power On	A long beep (1 second)
Good Read	A short beep
Programming	Sound from low to high
Exit	Sound from high to low

1.3.3 Vibration

Your scanner vibrates in certain status.

Status	Scanner
Power On	Vibrate
Good Read	Vibrate

2 Get started

This chapter provides information about how to install, connect and use your scanner to do your work.

2.1 Installation

This section describes how to set up your scanner.

2.1.1 Set up your scanner

1. Plug the RJ45 connector into your scanner's RJ45 port, until you hear a click.

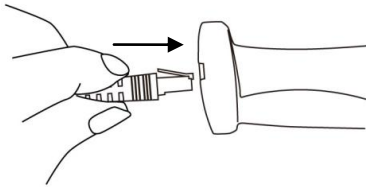

2. Connect the USB or the RS-232 connector to your computer.

Note If you've purchased the power supply, connect it to the RS-232 cable and the wall outlet.

3. Turn on your computer. It detects your scanner automatically.
4. To test your scanner, start a text processing program like Notepad or Word. Scan a bar code and see if the data can be sent to your computer. If it's successful, you'll hear a beep and the bar code data shows in the program.

2.1.2 How to scan

AI-6800 emits a light bar when it is scanning. This bar needs to cross the bar code horizontally to decode it.



2.1.3 Work with the ASCII table

Sometimes, you might need to send some control characters that can't be typed or enter characters without a keyboard. You can do it by using ASCII codes.

In *Appendix B*, you'll find the ASCII table. Both column and row numbers are hexadecimal. The ASCII code of a character is the combination of a column and a row number, where the column comes first. For example, the ASCII code of BEL is "07" and the number sign (#) is "23." You can use the bar codes in *Appendix D* to scan ASCII codes.

2.2 Unplug cable

Follow the step to unplug RJ45 cable

1. Loose and remove a screw as below.

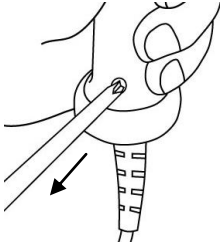

2. Use a pin to insert screw hole. Press latch and pull RJ45 connector out.

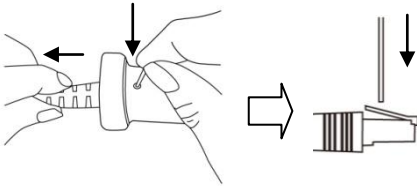

3. Unplug cable

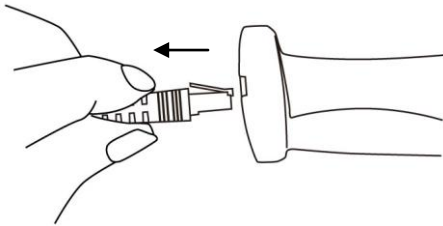

3 Controls and settings

Customize your scanner to work efficiently. AI-6800 offers many features to match your preferences. This chapter provides information about how to change controls and settings of your scanner.

■ User's Default Setting

After setting your device, you can save your setting as a User's default. If you reset your scanner to factory default, you can still load your setting in this function.



Save your current setting as default



Restore your default setting

To customize your scanner, you need to scan a series of programming bar codes in the correct order. On the last page of this manual, you'll see a table of hexadecimal bar codes that can be used with programming bar codes.

To customize your scanner:











1. On the top of the setting table, scan the **Program** bar code.
2. In the setting table, in the **Setting** column, scan one of the bar codes.
3. On the last page, scan the bar codes that correspond to the value you want in the **Value** column. When you finish, scan the **Finish** bar code.
4. On the lower-right corner of the setting table, scan the **Exit** bar code.







Scan Process

Program → Setting → Value (using bar codes on the last page) → Finish → Exit



Setting	Option	Value
 <code>*1AA*</code> Interface selection	RS-232	01
	USB HID	03
	RS-232/	} 04*
	USB HID	
	Auto detection	
USB Virtual COM	05	

 0
 1
 2
 3
 4
 5
 6
 7
 8
 9

 A
 B
 C
 D
 E
 F

 Finish

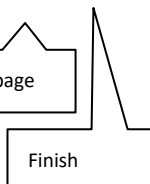
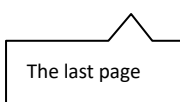
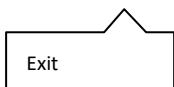
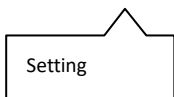

3.1 Interface selection

AI-6800 supports RS-232, USB HID and virtual COM. By default, your scanner is able to detect the interface automatically. When it detects USB, it selects HID as your scanner's interface.



\$%+PRO

Program

Setting	Option	Value
	RS-232	01
	USB HID	03
Interface selection	RS-232/ USB HID	} 04*
	Auto detection	
	USB Virtual COM	

(*) Default



%\$\$

Exit



3.1.1 USB HID key board



- **Keyboard layout** You can use it to change your keyboard layout, so your scanner can scan bar codes of different languages. Remember, you also need to change your input method.
- **Function key** It maps function keys to ASCII codes, so you can scan bar codes in place of the function key input. For example, if you scan the numeric bar code “1” and then “2,” your scanner sends the specific character to your computer as though you press F2. The code mapping range is from 01 to 1F. For more information about ASCII codes, see ASCII table in *Appendix B*.
- **Numeric key** The keypad is located to the rightmost of a keyboard. You need to select this mode if your program only accepts numerals. When selecting Alt+Keypad, your bar code data will be sent as if you’re pressing “Alt+number.” It is useful when your bar code contains a special character, such as the Euro sign (€).
- **Caps lock** It determines whether the state of the Caps Lock key affects the output of bar codes.
- **Block Delay** It is a delay timer between barcode data output. The feature is used to transfer continually with shorter barcode data or multi-field scanning.



\$%+PRO

Program

Setting	Option	Value
 *2AB* Keyboard layout	USA	00*
	Belgium	01
	Denmark	02
	France	03
	Germany	04
	Italy	05
	Portugal	06
	Spain	07
	Sweden	08
	Switzerland	09
	UK	10
	Latin American	11
	Japanese	12
 *2AD* Function key	Disable	00
	Enable	01*
 *2AE* Numeric key	Alphabetic key	00*
	Numeric keypad (Num lock state only)	01
	Alt+Keypad	02

Setting	Option	Value
 *2AF*	Caps lock"ON"	00
Caps lock	Caps lock"OFF"	01*
 *3AC*	00 to 99.	00 *
Block Delay		
(*) Default		



%\$\$

Exit

3.1.2 RS-232

- **Flow control**
 - **None** Your computer and scanner only use TxD and RxD signals for communication. No hardware or software flow control is used.
 - **RTS/CTS** It is hardware flow control. If your scanner is ready to send bar code data to your computer, it sends an RTS signal, and waits to receive a CTS signal from your computer. If your scanner doesn't receive a CTS after a timeout, you'll hear five warning beeps from it.
 - **Xon/Xoff** It is software flow control. When your computer is unable to receive data, it sends an Xoff signal to notify your scanner to stop sending data; it sends an Xon signal when it's ready.
 - **ACK/NAK** Your scanner sends data after it received an ACK signal from your computer, and will resend data if it receives an NAK signal.



- **Inter-character delay** It determines how fast your computer receives each character and displays it on the screen. If the speed is set too fast and your computer system is slow, your computer may lose data.

- **Response delay** If you use RTS/CTS or ACK/NAK for flow control, you can decide how long your scanner waits your computer to acknowledge the data transmission.



\$%+PRO

Program

Setting	Option	Value
 *3AA*	None	00*
Flow control	RTS/CTS	01
	Xon/Xoff	02
	ACK/NAK	03
 *3AB*	00-99 (msec)	00-99
Inter-character delay		00*
 *3AD*	00-99 (100 msec)	00-99
Response delay		20*
(*) Default		







%\$\$

Exit



\$%+PRO

Program

Setting	Option	Value
 *3AE* Baud rate	600 bps	01
	1200 bps	02
	2400 bps	03
	4800 bps	04
	9600 bps	05
	19200 bps	06
	38400 bps	07
	57600 bps	08
	115200 bps	09*
 *3AF* Parity	None	00*
	Odd	01
	Even	02
 *3AG* Data bit	8 bits	00*
	7 bits	01
 *3AH* Stop bit	One bit	00*
	Two bits	01

(*) Default



%\$\$

Exit

3.2 Scan properties

- **Good-read off** After you pull the trigger, your scanner will keep emitting the light bar, until it captures a good scan or no bar code is decoded after the stand-by duration elapsed.
- **Momentary** When you pull the trigger, the light bar is turned on; when you release the trigger, the light bar is turned off.
- **Alternate** The trigger acts as a toggle. When you pull the trigger, the light bar is turned on; when you pull it again, the light bar is turned off.
- **Timeout-off** When you pull the trigger, the light bar is turned on. If no bar code is decoded after the stand-by duration elapsed, the light bar is turned off.
- **Continue** It automatically detects and decodes bar codes in your scanner's field of view. You can turn on this mode when you want to decode bar codes without pulling the trigger. If no bar code is decoded after the stand-by duration elapsed, the light bar will flash. You can move your scanner or pull the trigger to wake it up.
- **Test only** It is reserved for engineers to test.
- **Auto-sensing** Similar to **Continue**, it automatically detects and decodes bar codes in your scanner's field of view. If no bar code is decoded after the stand-by duration elapsed, the light bar will be turned off. You can move your scanner or pull the trigger to wake it up.





- **Double read timeout** It determines the duration of **Double confirm**. For example, if you set 5 times in **Double confirm** and set 10 milliseconds in **Double read timeout**, the decoder will decode a bar code 5 times in 10 milliseconds. You need to turn on **Double confirm** to use this feature.
- **Double confirm** It determines how many times the decoder needs to confirm a bar code.
- **Global min/max code length** The min and max code length defines the decoding length of all bar codes. Note the following when you set their length:
 - If the length of a bar code is shorter than the min or longer than the max, the bar code won't be decoded.
 - If the min is equal to the max, the decoding length is fixed.
 - Some bar codes have their own decoding length. If you set the individual min or max decoding length for a bar code, your scanner will go by the individual setting.
- **Inverted image scan** When you turn on this feature, you can scan both regular and inverted bar codes.
- **Position indication** When you turn on this feature, the light bar keeps flashing. This feature determines how long the light bar flashes.

- **ISBT Concatenation timeout** when scanning single ISBT barcode, scanner will wait 900ms to output barcode because it is seeking appended ISBT barcode until timeout.



\$%+PRO

Program

Setting	Option	Value
 *7AA* Scan mode	Good-Read Off	00
	Momentary	01*
	Alternate	02
	Timeout Off	03
	Continue	04
	Test only	05
	Auto-sensing	06
 *7AB* Stand-by duration	01-99 (second)	00-99
		06*
 *7AC* Double read timeout	01-99 (10 msec)	01-99
		50*
 *7AD* Double confirm	00-09	00-09
	(00: no double confirm)	00*

(*) Default





%\$\$

Exit



\$%+PRO

Program

Setting	Option	Value
 *7AF* Global min. code length	00-99	00-99 4*
 *7AG* Global max. code length	00-99	04-99 99*
 *7AH* Inverted image scan	Disable Enable	00* 01

(*) Default





%\$\$

Exit



\$%+PRO

Program

Setting	Option	Value
 *7AK* Position indication	Disable	00*
	30 second	01
	60 second	02
	90 second	03
	120 second	04
	150 second	05
	180 second	06
	Continue	07
 *7AO* ISBT Concatenation timeout	關	00
	100ms	01
	200ms	02
	900ms	09
	(*) Default	



%\$\$

Exit







3.3 Indicator

- **Power on alert** When your scanner is turned on, you'll hear a long beep.
- **Good read indication** The reaction after your scanner gets a good read.
- **Beeper indication** Your scanner will beep after it gets a good read.
- **Beep loudness** It is the volume of the good read beep. The bigger the number, the higher the volume.
- **Beep tone freq** It is the tone of the good read beep. The bigger the number, the higher the tone.
- **Beep tone duration** It is the duration of the good read beep. The bigger the number, the longer the duration.



\$%+PRO

Program

Setting	Option	Value
 *5AA*	Disable	00
	Enable	01*
Power on alert		
 *5AB*	Disable	00
	Enable LED	01
	Enable Vibration	02
	Enable both	03*
Good read indication		
 *5AC*	Disable	00
	Enable	01*
Beeper indication		
 *5AD*	00-07	00-07
		07*
Beep loudness		
 *5AE*	00-99 (100 Hz)	00-99
		40*
Beep tone freq.		
 *5AF*	00-99 (10 msec)	00-99
		10*
Beep tone duration		

(*) Default



%\$\$

Exit

3.4 Characters and strings (transmission)

3.4.1 Prefix and suffix

Prefix / Suffix characters setting You can add a character at the beginning (prefix) or at the end (suffix) of a bar code. You can use up to 12 ASCII characters to customize the prefix and suffix.

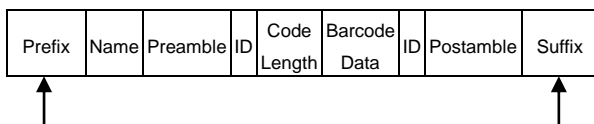

\$%+PRO Program

Setting	Option	Value
 8AA	None	00*
Prefix characters setting	1-22 characters	00-ffH ASCII code
 8AB	None	0D*
Suffix characters setting	1-22 characters	00-ffH ASCII code

(*) Default



Exit



Note Datamagic can help you up to 10 string with 12 characters.

3.4.2 Preamble and postamble



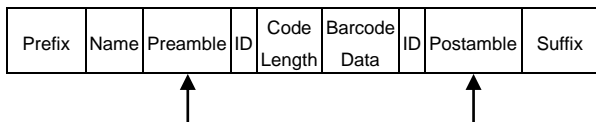

- **Preamble / Postamble** In some cases, you may need additional characters to identify your bar code data. A preamble and postamble can help you to do that. Remember, you need to turn on **preamble/postamble transmission** to use it.
- **Preamble transmission** Add a preamble character or characters to a bar code.
- **Postamble transmission** Add a postamble character or characters to a bar code.





\$%+PRO

Program

Setting	Option	Value
 *8AC*	None	00*
Preamble characters setting	1-12characters	00-ffH
		ASCII code
 *8AD*	None	00*
Postamble characters setting	1-12characters	00-ffH
		ASCII code
 *6AA*	Disable	00*
Preamble transmission	Enable	01
 *6AB*	Disable	00*
Postamble transmission	Enable	01

(*) Default



%\$\$

Exit

3.4.3 String groups

- **Insert G1/G2/G3/G4 character setting**
You can insert up to two strings into a bar code. Each string can contain up to 12 characters. First, you need to set a string in a group, and then insert the group into your bar code. There are four string groups. You can decide which group you want to use and where you want to insert it. You can insert the same group two times if you want.

Note if you want to insert G5-G10, use Data Magic.
- **Insert data group position** It determines the position that the string group will be inserted into. Note that the insertion position can't exceed the length of a bar code, or the group will be inserted at the end of the bar code. The value "00" inserts the group at the beginning of a bar code, and "64" inserts the group at the end of a bar code.

Example

To insert a string group into a bar code:

Step 1. Set a string in a group.

1. Scan the **Program** and **Insert G1 characters setting** bar codes.

2. In the ASCII code table, find the value of the character you want to insert. For example, if you want to insert the string "AB," you'll find A→41, B→42.
3. On the last page, scan "41" and "42," and then scan the **Finish** bar code.
4. Scan the **Exit** bar code.

Step 2. Insert the string into the specified position.

1. Scan the **Program** and **Insert data group 1 position** bar codes.
2. On the last page, scan "03," and then scan the **Finish** bar code. This means we're inserting the string into the third position of a bar code.
3. Scan the **Exit** bar code.

Step 3. Specify the bar code you want to insert.

1. We're using Code 128 as an example. In the section *Code 128*, scan the **Program** and **Insert group number selection** bar codes.
2. On the last page, scan "01," and then scan the **Finish** bar code. This means we're inserting Group1 into a Code 128 bar code.
3. Scan the **Exit** bar code.

Original data: 258963







Result: 258AB963



\$%+PRO

Program

Setting	Option	Value
 8AE Insert G1 characters setting	None	00*
	1-12 characters	00-ffH ASCII code
 8AF Insert G2 characters setting	None	00*
	1-12 characters	00-ffH ASCII code
 8AG Insert G3 characters setting	None	00*
	1-12 characters	00-ffH ASCII code
 8AH Insert G4 characters setting	None	00*
	1-12 characters	00-ffH ASCII code
 8AI Insert G5 characters setting	None	00*
	1-12 characters	00-ffH ASCII code
 8AJ Insert G6 characters setting	None	00*
	1-12 characters	00-ffH ASCII code
 8AK Insert G7 characters setting	None	00*
	1-12 characters	00-ffH ASCII code

Setting	Option	Value
 * 8 A L * Insert G8 characters setting	None	00*
	1-12 characters	00-ffH ASCII code
 * 8 A M * Insert G9 characters setting	None	00*
	1-12 characters	00-ffH ASCII code
 * 8 A N * Insert G10 characters setting	None	00*
	1-12 characters	00-ffH ASCII code
 *6AC* Insert data group 1 position	00-63 (00: no insertion)	00-63 00*
 *6AD* Insert data group 2 position	00-63 (00: no insertion)	00-63 00*
 *6AE* Insert data group 3 position	00-63 (00: no insertion)	00-63 00*
 *6AF* Insert data group 4 position	00-63 (00: no insertion)	00-63 00*

(*) Default



3.4.4 ID, name and capitalization

- **Code ID position** You can choose to place Code ID before or after a bar code.

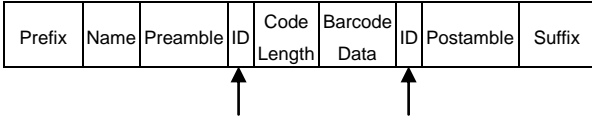





- **Code ID transmission** Code ID is an identifier for a bar code. It has two modes: Proprietary ID or AIM ID. You can choose either of them. If you want to customize the code ID using an ASCII code, you need to choose Proprietary ID. AIM ID is fixed since it is defined by the AIM organization.
- **Code length transmission** It shows the length of a bar code at its beginning. For example, if your bar code is "258963," the result will be "06258963," in which 06 is the length.
- **Code name transmission** It shows the name of a bar code type at the beginning of a bar code. For example, if your bar code type is Code 39, and your bar code is "09741258R," the result is "(Code-39) 09741258R."
- **Case conversion** You can change the capitalization of letters. For example, if you choose Upper case, the string "12aBcDeF" will be converted to "12ABCDEf."



\$%+PRO

Program

Setting	Option	Value
 *6AG*	Before code data	00*
	After code data	01
Code ID position		
 *6AH*	Disable	00*
	Proprietary ID	01
Code ID transmission	AIM ID	02
 *6AI*	Disable	00*
	Enable	01
Code length transmission		
 *6AJ*	Disable	00*
	Enable	01
Code name transmission		
 *6AK*	Disable	00*
	Upper case	01
	Lower case	02
Case conversion	(For bar code data only)	

(*) Default



%\$\$

Exit

3.5 Scanner information

3.5.1 Parameters

It displays your scanner's information on the screen.

- **Bar code settings** It shows the current settings of all bar codes.
- **Unique parameters** It shows the current values of the common properties of all bar codes.
- **System parameters** It shows the current system settings of your scanner, such as interface selection, RS-232, indicator, transmission and the scan mode.
- **String settings** It shows all settings of strings, such as prefix, suffix, preamble, postamble and string groups.



\$%+PRO

Program

Setting



!BS

Bar code settings



!BU

Unique parameters



!SY

System parameters



!ST

String settings



%\$\$

Exit

3.5.2 Data Magic settings

It shows all settings of Data Magic.



\$%+PRO

Program

Setting



!DM

Data Magic settings



%\$\$

Exit

3.5.3 Firmware version

It shows the firmware version of your scanner.



\$%+PRO

Program

Setting



!VR

Firmware version



%\$\$

Exit

3.6 Reset your scanner

By resetting your scanner, you can return your scanner to the state it was in when you receive it. This can help you solve some problems caused by settings changed between scans.

Scan the following bar code to reset your scanner:



\$%+PRO

Program

Setting



!IN

Reset your scanner

3.7 Update firmware

Updating firmware improves functionalities and performance for your scanner. Take the following steps to update firmware.

- USB connection
- 1. Start Scan Utility.
- 2. On the **File** menu, click **New**.

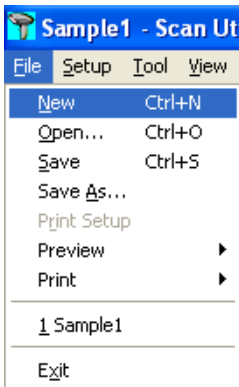

- 3. In the **NEW** dialog box, select **AI6800** from the **Select Model** list, and click **OK**.

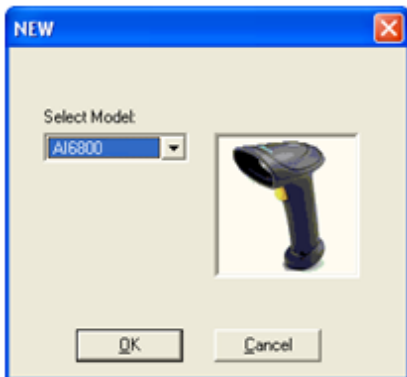

4. In the **Scan Utility** dialog box, click **No**.

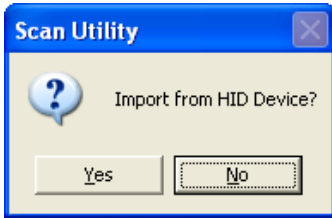

5. On the **Tool** menu, click **Download Firmware > Download All (Scanner)**.

Note If you want to exit the firmware update mode, unplug the cable.

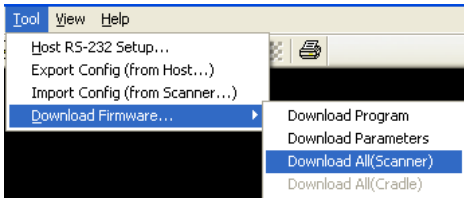

6. Scan Utility will ask if you want to upgrade your scanner, click **OK**. In the next dialog box, click **OK**. Then, you need to wait 7 seconds for system to switch your scanner to the DFU mode.

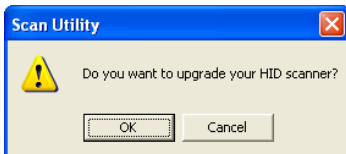

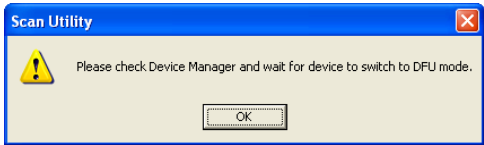

7. In the **Change Firmware** dialog box, click **Ask** to get the current firmware version of your scanner.

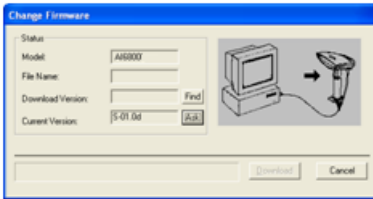

8. Click **Find** to load the firmware file. The firmware version in this file needs to be different from the current firmware version of your scanner. After loading the file, click **Download** to update the firmware.

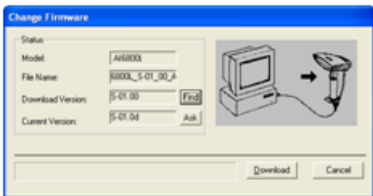

9. After the update is completed, click **OK**.

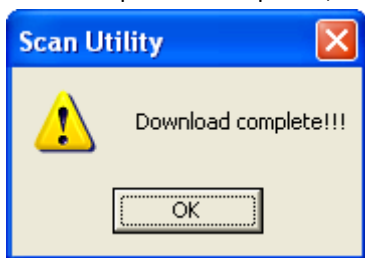

- RS-232 connection
1. Start Scan Utility.
 2. On the **File** menu, click **New**.

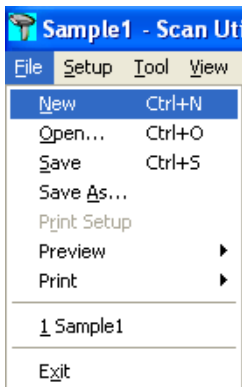

3. In the **NEW** dialog box, select **AI6800** from the **Select Model** list, and click **OK**.

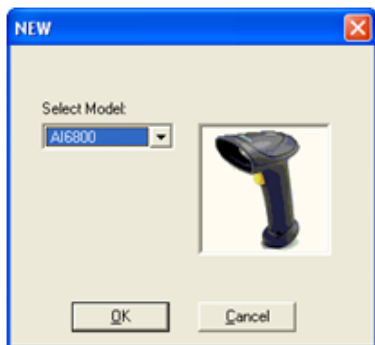

4. In the **Scan Utility** dialog box, click **No**.

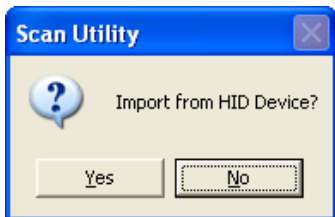

5. On the **Tool** menu, click **Host RS-232 Setup**.

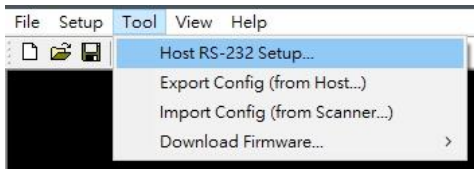

6. In the **Host RS-232 Setup** dialog box, select the COM port your scanner is using and click **Port Setting**.

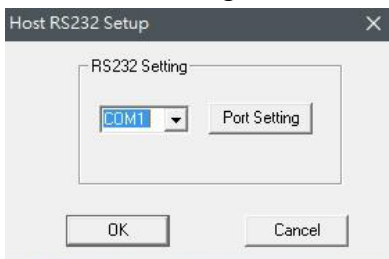

7. In the **Port Setting** dialog box, in the **Baud rate** list, select **115200** and click **OK**.

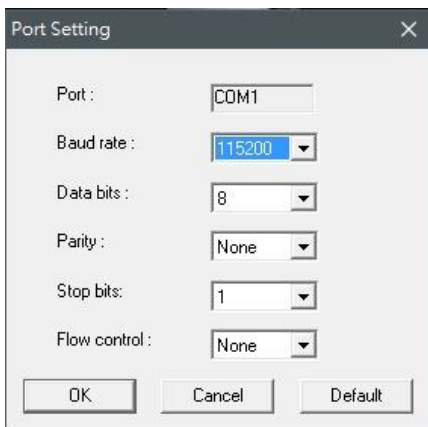

- In the **Host RS-232 Setup** dialog box, click **OK**.

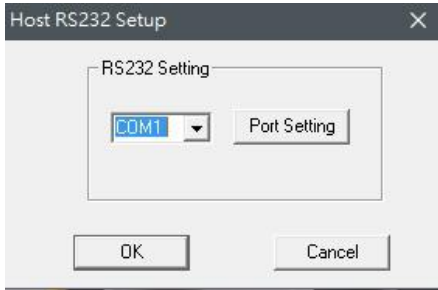

- On the **Tool** menu, click **Download Firmware > Download All (Scanner)**.

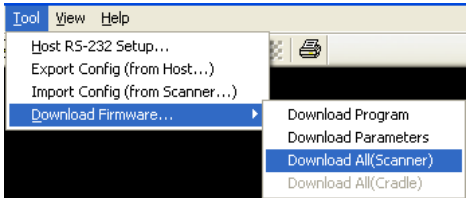

- In the **Change Firmware** dialog box, click **Ask** to get the current firmware version of your scanner.

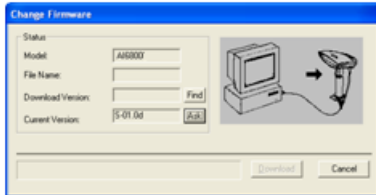

11. Click **Find** to load the firmware file. The firmware version in this file needs to be different from the current firmware version of your scanner. After loading the file, click **Download** to update the firmware.

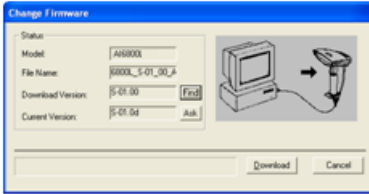

12. After the update is completed, click **OK**.

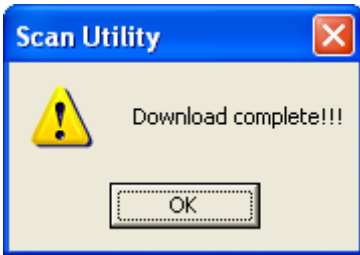

Install driver

If your operating system is Windows XP, it may ask you to install the driver for AI-6800 during the firmware updating process. Take the following steps to install it.

1. In the **Found New Hardware Wizard** dialog box, click **Install from a list or specific location (Advanced)**, and click **Next**.

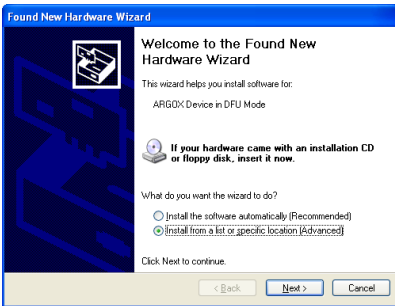

2. Select the **Include this location in the search** check box, and click **Browse**. The default path of driver of AI-6800 is C:\Program Files\Argox\Your Scan Utility version\driver\DFU. After setting the path, click **Next**.

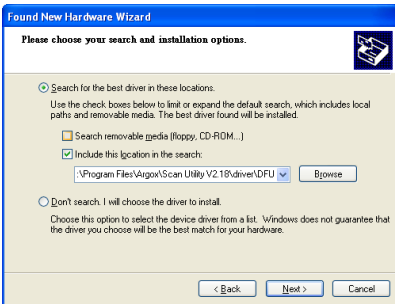

3. The system starts to install the driver.
After it is completed, click **Finish**.



3.8 Data Magic

Data Magic offers 10 commands for you to customize text strings of bar codes. Each command can be specified in a rule. Data Magic allows up to 10 rules to be applied. With the flexibility Data Magic provides, you can define data as you want.

There are two ways to use Data Magic: scanning bar codes, or using Scan Utility. By scanning bar codes, you can quickly change the settings without using programs; by using Scan Utility, you can see the settings at a glance and change them through the easy-operated user interface. Choose the method that meets your need.



Important Data Magic default is disabled. To enable Data Magic function, go to chapter 4 [Bar codes](#) and find Data Magic column to enable it.

Data Magic commands

InsertF

Definition

Insert a character or characters from the left of a text string.

Attributes

- Position: The position you want to insert the character.
- String: The specified group.

InsertB

Definition

Insert a character or characters from the right of a text string.

Attributes

- Position: The position you want to insert the character.
- String: The specified group.

CutF

Definition

Remove a character or characters from the left of a text string.

Attributes

- From: The starting position of the text to be removed.
- To: The end position of the text to be removed.

CutB

Definition

Remove a character or characters from the right of a text string.

Attributes

- From: The starting position of the text to be removed.
- To: The end position of the text to be removed.

KeepF

Definition

Retain a character or characters from the left of a text string.

Attributes

- From: The starting position of the text to be retained.
- To: The end position of the text to be retained.

KeepB

Definition

Retain a character or characters from the right of a text string.

Attributes

- From: The starting position of the text to be retained.
- To: The end position of the text to be retained.

FindF

Definition

Remove a certain length of the string from the left.

Attributes

- String: The specified group.
- Include: Remove everything before the specified string.
- Exclude: Remove the specified string and everything before it.

FindB

Definition

Remove a certain length of the string from the right.

Attributes

- String: The specified group.
- Include: Remove everything before the specified string.
- Exclude: Remove the specified string and everything before it.

Replace

Definition

Replace the text in the original text string with a different text string.

Attributes

- String: The text in the original text string.
- With String: The string that replaces the specific text.

Erase

Definition

Remove the specified rule.

Attributes

None.

Position Range: 0-99

Cut Range: From: 1-99, To: 1-99



Note If you use Data Magic by scanning bar codes, you don't need the Erase command.

3.8.1 Bar code scanning

Bar code scanning is a quick way to work with Data Magic. Just scan the bar codes in specific order, and you can customize your string in seconds.

Data format

Data Magic provides 10 rules for you to set. To set a rule, follow this data format to scan bar codes:

Program + Rule + Command + Attribute 1 + Attribute 2 + Finish + Exit

Item	Description
Rule	The rule number. The lower the number, the higher the priority. The rule with the high priority will be applied first.
Command	The command you specify in the rule.
Attribute 1	The attribute varies according to the command.
Attribute 2	The attribute varies according to the command.

Command	Attribute 1	Attribute 2
InsertF	Position	String
InsertB	Position	String
CutF	From	To
CutB	From	To
KeepF	From	To
KeepB	From	To
FindF	String	Include or Exclude
FindB	String	Include or Exclude
Replace	String	With String
Erase	-	-

To set an InsertF rule with the sample data, scan the following bar codes:

Program



RULE1



InsertF



Attr1 (Two digits)



Attr2 (Two digits)



Finish













Exit



Bar codes

The bar codes below are Data Magic rules. They consist of two digits. The first digit “9” indicates Data Magic; the second indicates the rule number.

Data Magic Rules	
RULE 1  *90*	RULE 2  *91*
RULE 3  *92*	RULE 4  *93*
RULE 5  *94*	RULE 6  *95*
RULE 7  *96*	RULE 8  *97*
RULE 9  *98*	RULE 10  *99*

The bar codes below are Data Magic commands.

Data Magic Commands



* / 0 *

0→InsertF



* / 1 *

1→CutF



* / 2 *

2→CutB



* / 3 *

3→Replace



* / 4 *

4→KeepF



* / 5 *

5→KeepB



* / 6 *

6→FindF



* / 7 *

7→FindB



* / 8 *

8→InsertB



* / 9 *

9→Erase

Example

Original Text String: ARGOX89121121

Group 1: ARGOX Group 2: argox

Group 3: GOX Group 4: Tel:

InsertF

Insert Group 4 (Attr 2) into the fifth (Attr 1)
position from the left side of the string.

Program							
Rule	Command	Attribute 1		Attribute 2		Finish	Exit
1	InsertF	0	5	0	4		

Data: ARGOX89121121

Result: ARGOXTel:89121121

InsertB

Insert Group 4 (Attr 2) into the eighth (Attr 1)
position from the right of the string.

Program							
Rule	Command	Attribute 1		Attribute 2		Finish	Exit
2	InsertB	0	8	0	4		

Data: ARGOX89121121

Result: ARGOXTel:89121121

CutF

Remove first 5 characters from the left of the string.

Program							
Rule	Command	Attribute 1		Attribute 2		Finish	Exit
3	CutF	0	1	0	5		

Data: ARGOX89121121

Result: 89121121

CutB

Remove first 8 characters from the right of the string.

Program							
Rule	Command	Attribute 1		Attribute 2		Finish	Exit
4	CutB	0	1	0	8		

Data: ARGOX89121121

Result: ARGOX

Replace

In the original string, replace the Group 1 (Attr1) with Group 4 (Attr2).

Program							
Rule	Command	Attribute 1		Attribute 2		Finish	Exit
5	Replace	0	1	0	4		

Data: ARGOX89121121

Result: Tel:89121121

KeepF

Keep the characters from (Attr1) to (Attr2) from the left of the string.

Program							
Rule	Command	Attribute 1		Attribute 2		Finish	Exit
6	KeepF	0	3	0	8		

Data: ARGOX89121121

Result: GOX891

KeepB

Retain the characters from (Attr1) to (Attr2) from the right of the string.

Program							
Rule	Command	Attribute 1		Attribute 2		Finish	Exit
7	KeepB	0	3	0	8		

Data: ARGOX89121121

Result: 891211

FindF

Remove Group 3 (Attr 1) and everything before it from the left of the string. Attribute 2 can be "00" or "01."

Program							
Rule	Command	Attribute 1		Attribute 2		Finish	Exit
8	FindF	0	3	0	1		

00: Include

01: Exclude

Data: ARGOX89121121

Data: ARGOX89121121

Result: GOX89121121

Result: 89121121

FindB

Remove Group 3 (Attr 1) and everything before it from the right of the string. Attribute 2 can be "00" or "01."

Program							
Rule	Command	Attribute 1		Attribute 2		Finish	Exit
9	FindB	0	3	0	1		

00: Include

01: Exclude

Data: ARGOX89121121

Data: ARGOX89121121

Result: ARGOX

Result: AR

Erase

Remove the specified rule.

Program	Rule	Command	Exit
	Rule 10	Erase	

Erase

To remove all values in Data Magic, scan the bar code below.



Display the current settings

To display the current settings of Data Magic, scan the following bar codes:

Program



OR



Display Data Magic
settings



Displays Inserted
Group settings



Scan Utility

Scan Utility provides a simple, clear interface that you can easily view and change Data Magic settings, and import or export the settings to your scanner. Currently, Scan Utility uses RS-232 for data transmission. If your scanner is connected via a USB port, you need to install Virtual COM for Scan Utility to transmit data. For more information about installing Virtual COM, see *Virtual COM*.

To use Data Magic, start Scan Utility and do this:

1. On the **File** menu, click **New**.
2. In the **NEW** dialog box, select **AI6800** from the **Select Model** list, and click **OK**.
3. In the **Scan Utility** dialog box, click **No**.
4. On the **Setup** menu, Click **Linear Barcode setup**. Select which code you want to use then enable **Data matrix** function, click **OK**.
5. On the **Setup** menu, click **Scanner Setup**, and click the **Data Magic** tab.
6. In the **Data Magic** tab, select the **Data Magic** check box.
7. Click one of the rules you want to set. For example, if you want to set **Rule 1**, select its **Enable** check box. In the command list, click the command you want, such as **InsertF**. In the **position** box, type a position number. In the **string** list, click the group you want.

8. Repeat the previous step until you set all the rules you need, and click the **String** tab.
9. In the **String** tab, there are 10 string boxes: **Insert G1-G10 chars setting**. Each box corresponds to the group you've selected in the **string** list in the **Data Magic** tab. Depending on your selection, type the text you want in the specific box. For example, if you've selected **Group1**, type in the **Insert G1 chars setting** box. The string box accepts up to 12 single-byte characters. When you're done, click **OK**.
10. On the **Tool** menu, click **Export Config (from Host)**, and click **Export**. If the data is exported successfully, you'll hear a long beep.

In the **Data Magic** tab, you'll find 10 rules.
Each rule can be set to one of the commands.
The table below describes how to use those commands.

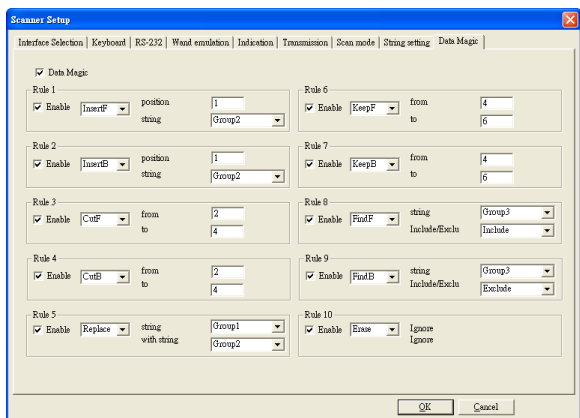

Command	Example
InsertF	Position: 1 String: Group 2 Group 2: Argox Original String: 12345678 Result: 1Argox2345678
InsertB	Position: 1 String: Group 2 Group 2: Argox Original String: 12345678 Result: 1234567Argox8
CutF	From: 2 To: 4 Original String: 12345678 Result: 15678
CutB	From: 2 To: 4 Original String: 12345678 Result: 12348

Command	Example
Replace	String: Group1 With String: Group 2 Group 1: 456 Group 2: Argox Original String: 123 <u>456</u> 78 Result: 123 <u>Argox</u> 78
KeepF	From: 2 To: 4 Original String: 123 <u>456</u> 78 Result: 234
KeepB	From: 2 To: 4 Original String: 1234 <u>567</u> 8 Result: 567
FindF	String: Group 3 Group 3: 45 Original String: 1234 <u>56</u> 78 Include/Exclu: Include <ul style="list-style-type: none">■ Result: <u>45</u>678 Include/Exclu: Exclude <ul style="list-style-type: none">■ Result: 678
FindB	String: Group 3 Group 4: 45 Original String: 1234 <u>56</u> 78 Include/Exclu: Include <ul style="list-style-type: none">■ Result: 123<u>45</u> Include/Exclu: Exclude <ul style="list-style-type: none">■ Result: 123
Erase	In Rule 10, In the command list, click Erase , and Rule 10 will be removed. You can also clear the Enable check box to remove the rule.

Virtual COM

You can configure Virtual COM to transmit data to a computer via a virtual COM port. After installing Virtual COM, your scanner will be assigned a virtual COM port, which you can use to receive or send data.

To configure Virtual COM on Windows XP and set up a virtual COM port in Scan Utility:

1. Connect your scanner to your computer.
2. Use the bar code in *Interface Selection* to switch the interface to **Virtual COM**. If the interface is set successful, you'll hear a long beep, and **Found New Hardware Wizard** will appear on screen.
3. In the **Found New Hardware Wizard** dialog box, click **Install from a list or specific location (Advanced)**, and click **Next**.
4. Click **Search for the best driver in these locations**, and select the **Include this location in the search** check box. Next, click **Browse**, and find the driver at your installation path of Scan Utility (default is C:\Program Files\Argox\Scan Utility\driver\virtual com), and then click **Next**.
5. After the driver installed, click **Finish**.
6. Right-click **My Computer** and click **Properties**.
7. Click the **Hardware** tab, and click **Device Manager**.

8. Click **Ports (COM & LPT)**. Find **ARGOX Virtual COM** and see the port number in the parenthesis.
9. Close **Device Manager**.
10. Start Scan Utility. On the **File** menu, click **New**. In the **Select Model** list, click **AI6800**, and click **OK**.
11. On the **Tool** menu, click **Host RS-232 Setup**.
12. In the **Host RS-232 Setup** dialog box, in the **RS-232 Setting** list, click the port you've seen in step 8, and click **Port Setting**.
13. In the **Port Setting** dialog box, in the **Baud rate** list, click **115200**, and click **OK**.



Note The installation steps may vary depending on your operating system.

4 Bar codes

Each bar code has different attributes for you to change as you need.

UPC-A

Format

Leading Zero	Data Digits (11 Digits)	Check Digit
-----------------	----------------------------	----------------

- **Read** Turn on or turn off the read function.
- **Checksum transmission** Append the check digit to the end of a bar code.
- **Data Magic** Turn on or turn off Data Magic.
- **Truncate leading/ending** You can truncate characters from the left (Truncate leading) or the right (Truncate ending) of a bar code. Your scanner beeps if the truncate length is longer than the bar code, or the parts being truncated by Truncate leading and Truncate ending are overlapped. You can truncate up to 15 characters.
- **Code ID setting** Code ID is an identifier for a bar code. It has two modes: Proprietary ID or AIM ID. If you want to customize the code ID using an ASCII code, you need to choose Proprietary ID. You must turn on **Code ID transmission** to use Code ID. For further details, see Section 3.4.4, [ID, name and capitalization](#).



\$%+PRO

Program

Setting	Option	Value
	Disable	00
NAA	Enable	01*
Read		
	Disable	00
NAB	Enable	01*
Checksum transmission		
	Disable	00*
NAC	Enable	01
Data Magic		
	0-15	00-15
NAF		00*
Truncate leading		
	0-15	00-15
NAG		00*
Truncate ending		
	00-ffH	00-ffH
NAH	ASCII code	< A >*
Code ID setting		



%\$\$

Exit

■ Insertion group number selection

It allows you to insert up to two strings into a bar code. First, you need to set a string in a group, and then insert the group into your bar code. There are four string groups. You can insert the same group two times if you want. For more information about how to set a string in a group, see Section 3.4.3, [String groups](#).

Example:

To insert Group 2, set the value as 02 or 20.

To insert Group 1 and 4, set the value as 14 or 41.

To insert Group 3 two times, set the value as 33.

Note Zero (0) means no group is inserted.



- Supplement digits** If your bar code has a supplemental bar code, you can use this feature to decode it. The supplemental bar code can be 2 or 5 digits.

Leading Zero	Data Digits (11 Digits)	Check Digit	Supplement digits 2 or 5 or UCC / EAN 128
--------------	-------------------------	-------------	---



\$%+PRO

Program

Setting	Option	Value
 *NAI* Insert group number selection	00-44	00-44
	(The range of the single-digit number: 0-4)	00*
 *NAJ* Supplement digits	None	00*
	2 digits	01
	5 digits	02
	2,5 digits	03
	UCC/EAN 128	04
	2, UCC/EAN 128	05
	5, UCC/EAN 128	06
All	07	



%\$\$



Exit

■ **Truncation/Expansion**

- **Truncate** It truncates the leading zeros of a UPC-A bar code.
- **Expansion** It converts a UPC-A bar code to the EAN-13 format.

- **Supplement check counter** The decoder needs to capture the supplemental bar code within the number of times the check counter specified, or it determines there's no supplement. If you setting 00, it will be failed when you read supplemental bar code.



Setting	Option	Value
 *NAK*	None	00
Truncation/ Expansion	Truncate leading zero	01*
	Expand to EAN13	02
 *7AE*	00-99	00-99
	(verification)	5*
Supplement check counter		







UPC-E

Format

Leading Zero	Data Digits (6 Digits)	Check Digits
--------------	---------------------------	--------------

- **Read** Turn on or turn off the read function.
- **Checksum transmission** Append the check digit to the end of a bar code.
- **Data Magic** Turn on or turn off Data Magic.
- **Truncate leading/ending** See the description in UPC-A.
- **Code ID setting** See the description in UPC-A.



Setting	Option	Value
 *OAA* Read	Disable	00
	Enable	01*
 *OAB* Checksum transmission	Disable	00
	Enable	01*
 *OAC* Data Magic	Disable	00*
	Enable	01
 *OAF* Truncate leading	0-15	00-15
		00*

Setting	Option	Value
 *OAG*	0-15	00-15
Truncate ending		00*
 *OAH*	00-ffH ASCII code	00-ffH
Code ID setting		< E >*



%\$\$

Exit

- **Insertion group number selection** See the description in UPC-A.
- **Supplement digits** See the description in UPC-A.

Format

Leading Zero	Data Digits (6 Digits)	Check Digit	Supplement digits 2 or 5 or UCC / EAN 128
--------------	------------------------	-------------	---

- **Truncate/Expansion**
 - **Truncate** It truncates the leading zeros of a UPC-E bar code.
 - **Expansion** It converts a UPC-E bar code to the EAN-13 or UPC-A format.
- **Expansion** It extends a UPC-E bar code to 13-digit.
- **UPC-E1** It allows your scanner to decode UPC-E bar codes that begin with the number one (1).
- **Supplement check counter** See the description in UPC-A.



\$%+PRO

Program

Setting	Option	Value
---------	--------	-------



OAI

00-44

00-44

00*

Insert group
number selection



OAJ

None

00*

2 digits

01

Supplement digits

5 digits

02

2,5 digits

03

UCC/EAN 128

04

2, UCC/EAN 128

05

5, UCC/EAN 128

06

All

07



OAK

None

00*

Truncation/Expansion

Truncate leading
zero

01

Expand to EAN13

02

Expand to UPCA

03



OAL

Disable

00*

Expansion

Enable

01



OAM

Disable

00*

Enable

01

UPCE-1



7AE

00-99

00-99

(verification)

05*

Supplement check
counter



%\$\$

Exit

EAN-13





Format

Data Digits (12 Digits)	Check Digits
-------------------------	--------------

- **Read** Turn on or turn off the read function.
- **Checksum transmission** Append the check digit to the end of a bar code.
- **Data Magic** Turn on or turn off Data Magic.
- **Truncate leading/ending** See the description in UPC-A.



\$%+PRO Program

Setting	Option	Value
 *GAA* Read	Disable	00
	Enable	01*
 *GAB* Checksum transmission	Disable	00
	Enable	01*
 *GAC* Data Magic	Disable	00*
	Enable	01
 *GAF* Truncate leading	0-15	00-15
		00*
 *GAG* Truncate ending	0-15	00-15
		00*



%\$\$ Exit

- **Code ID setting** See the description in UPC-A.
- **Insertion group number selection** See the description in UPC-A.
- **Supplement digits** See the description in UPC-A.

Format

Data Digits (12 Digits)	Check Digits	Supplement Digits 2 or 5 or UCC / EAN 128
----------------------------	-----------------	---

- **ISBN/ISSN conversion** The ISBN (International Standard Book Number) and ISSN (International Standard Serial Number) are bar codes for books and magazines, respectively. The old ISBN is 10-digit and the old ISSN is 8-digit. When you turn on this feature, it converts the new ISBN and ISSN to their old format.
- **ISBN ID Setting** You can set ISBN ID with ASC II code.
- **Supplement check counter** See the description in UPC-A.



\$%+PRO

Program

Setting	Option	Value
	00-ffH ASCII code	00-ffH
GAH		< F >*
Code ID setting		
	00-44	00-44
GAI		00*
Insert group number selection		
	None	00*
GAJ	2 digits	01
Supplement digits	5 digits	02
	2,5 digits	03
	UCC/EAN 128	04
	2, UCC/EAN 128	05
	5, UCC/EAN 128	06
	All	07
	Disable	00*
GAL	Enable	01
ISBN/ISSN conversion		
	00-ffH ASCII code	00-ffH
GAM		< I >*
ISBN ID setting		
	00-99	00-99
7AE	(verification)	05*
Supplement check counter		



%\$\$

Exit

EAN-8

Format

Data Digits (7 Digits)	Check Digits
------------------------	--------------

- **Read** Turn on or turn off the read function.
- **Checksum transmission** Append the check digit to the end of a bar code.
- **Data Magic** Turn on or turn off Data Magic.
- **Truncate leading/ending** See the description in UPC-A.
- **Code ID setting** See the description in UPC-A.
- **Insertion group number selection** See the description in UPC-A.



\$%+PRO

Program

Setting	Option	Value
	Disable	00
	Enable	01*
Read		
	Disable	00
	Enable	01*
Checksum transmission		
	Disable	00*
	Enable	01
Data Magic		
	0-15	00-15
		00*
Truncate leading		
	0-15	00-15
		00*
Truncate ending		
	Two characters	00-ffH,
	00-ffH ASCII	00-ffH
Code ID setting	code	< FF >*
	00-44	00-44
		00*
Insert group number selection		



%\$\$

Exit

- **Supplement digits** See the description in UPC-A.

Format

Data Digits (7 Digits)	Check Digits	Supplement Digits 2 or 5 or UCC/EAN 128
------------------------------	-----------------	---

- **Truncate/Expansion**
 - **Truncate** It truncates the leading zeros of an EAN-8 bar code.
 - **Expansion** It converts an EAN-8 bar code to the EAN-13 format.
- **Expansion** It extends an EAN-8 bar code to 13-digit.
- **Supplement check counter** See the description in UPC-A.



\$%+PRO

Program

Setting	Option	Value
Supplement digits	None	00*
	2 digits	01
	5 digits	02
	2,5 digits	03
	UCC/EAN 128	04
	2, UCC/EAN 128	05
	5, UCC/EAN 128	06
	All	07
Truncation / Expansion	None	00*
	Truncate leading zero	01
	Expand to EAN13	02
Expansion	Disable	00*
	Enable	01
Supplement check counter	00-99	00-99
	(verifications)	05*



%\$\$

Exit

Code 39

Format









Start “★”	Data Digits (Variable)	Checksum (Optional)	End “★”
--------------	----------------------------	------------------------	------------

- **Read** Turn on or turn off the read function.
- **Checksum transmit/verify** When you disable both of them, the check digit is sent as a regular character.
 - **Transmission** Append the check digit to the end of a bar code.
 - **Verify** Use the algorithm to calculate a check digit to verify the completeness of the bar code.
- **Data Magic** Turn on or turn off Data Magic.
- **Max/Min code length** The max and min code length defines the decoding length of a bar code. Note the following when you set it length:
 - If the code length is shorter than the min or longer than the max, the bar code won't be decoded.
 - If the min is equal to the max, the decoding length is fixed.
 - If the max or min is set to zero (00), **Global min/max code length** will take effect. For example, if the min is set to zero, it will apply **Global min. code length**.
- **Truncate leading/ending** See the description in UPC-A.
- **Code ID setting** See the description in UPC-A.



\$%+PRO

Program

Setting	Option	Value
 *BAA* Read	Disable	00
	Enable	01*
 *BAB* Checksum	Disable/Disable	00*
	Disable/Enable	01
transmit/verify  *BAC* Data Magic	Enable /Enable	02
	Disable	00*
Enable  *BAD* Max. code length	00-64	00-64
		00*
 *BAE* Min. code length	00-64	00-64
		01*
 *BAF* Truncate leading	0-20	00-20
		00*
 *BAG* Truncate ending	0-15	00-15
		00*
 *BAH* Code ID setting	00-ffH ASCII code	00-ffH
		<*>



%\$\$





Exit

- **Insertion group number selection** See the description in UPC-A.
- **Format** It converts the ASCII codes in the Code 39 bar code to regular characters.
- **Append** It decodes and concatenates several Code 39 bar codes that have a space character at their beginning. Your scanner stops concatenating and sends all concatenated data to your computer when it decodes a Code 39 bar code that doesn't have a space character at its beginning, or when it decodes a bar code that is not Code 39.
If your scanner decodes a bar code that has a space character at its beginning, it won't send its Code ID, Preamble and Prefix; if it decodes a bar code that doesn't have a space character, it won't send its Code ID and Prefix.
- **Start/End transmission**
It sends the start and the stop codes of a bar code to your computer.



\$%+PRO

Program

Setting	Option	Value
 *BAI* Insert group number selection	00-44	00-44
		00*
 *BAJ* Format	Standard	00*
	Full ASCII	01
 *BAK* Append	Disable	00*
	Enable	01
 *BAM* Start/end transmission	Disable	00*
	Enable	01



%\$\$

Exit

Interleaved 2 of 5

Format



Data Digits (Variable)	Checksum (Optional)
---------------------------	------------------------







- **Read** Turn on or turn off the read function.
- **Checksum transmit/verify** See the description in Code 39.
- **Data Magic** Turn on or turn off Data Magic.
- **Max/Min code length** See the description in Code 39.
- **Truncate leading/ending** See the description in UPC-A.
- **Code ID setting** See the description in UPC-A.
- **Insertion group number selection** See the description in UPC-A.



\$%+PRO

Program

Setting	Option	Value
 *IAA* Read	Disable	00
	Enable	01*
 *IAB* Checksum transmit/verify	Disable/Disable	00*
	Disable/Enable	01
 *IAC* Data Magic	Disable	00*
	Enable	01

Setting	Option	Value
 *IAD*	00-64	00-64
Max. code leading		00*
 *IAE*	00-64	00-64
Min. code leading		00*
 *IAF*	0-15	00-15
Truncate leading		00*
 *IAG*	0-15	00-15
Truncate ending		00*
 *IAH*	00-ffH ASCII code	00-ffH
Code ID setting		< i >*
 *IAI*	00-44	00-44
Insert group number selection		00*

%\$\$ Exit

Industrial 2 of 5

Format





Data Digits (Variable)	Checksum (Optional)
---------------------------	------------------------

- **Read** Turn on or turn off the read function.
- **Data Magic** Turn on or turn off Data Magic.
- **Max/Min code length** See the description in Code 39.
- **Truncate leading/ending** See the description in UPC-A.
- **Code ID setting** See the description in UPC-A.
- **Insertion group number selection** See the description in UPC-A.



\$%+PRO

Program

Setting	Option	Value
 *HAA* Read	Disable	00*
	Enable	01
 *HAC* Data Magic	Disable	00*
	Enable	01
 *HAD* Max. code length	00-64	00-64
		00*
 *HAE* Min. code length	00-64	00-64
		00*
 *HAF* Truncate leading	0-15	00-15
		00*

Setting	Option	Value
 *HAG*	0-15	00-15
Truncate ending		00*
 *HAH*	00-ffH ASCII code	00-ffH
Code ID setting		< i >*
 *HAI*	00-44	00-44
Insert group number selection		00*



Exit

Matrix 2 of 5

Format



Data Digits (Variable)	Checksum (Optional)
---------------------------	------------------------







- **Read** Turn on or turn off the read function.
- **Checksum transmit/verify** See the description in Code 39.
- **Data Magic** Turn on or turn off Data Magic.
- **Max/Min code length** See the description in Code 39.
- **Truncate leading/ending** See the description in UPC-A.
- **Code ID setting** See the description in UPC-A.
- **Insertion group number selection** See the description in UPC-A.



\$%+PRO

Program

Setting	Option	Value
 *PAA* Read	Disable	00*
	Enable	01
 *PAB* Checksum transmit/verify	Disable/Disable	00*
	Disable/Enable	01
	Enable /Enable	02
 *PAC* Data Magic	Disable	00*
	Enable	01

Setting	Option	Value
 *PAD*	00-64	00-64
Max. code length		00*
 *PAE*	00-64	00-64
Min. code length		00*
 *PAF*	0-15	00-15
Truncate leading		00*
 *PAG*	0-15	00-15
Truncate ending		00*
 *PAH*	00-ffH ASCII code	00-ffH
Code ID setting		< B >*
 *PAI*	00-44	44
Insert group number selection		00*

%\$\$ Exit



Codabar





Format

Start	Data Digits (Variable)	Checksum (Optional)	End
-------	------------------------	---------------------	-----

- **Read** Turn on or turn off the read function.
- **Checksum transmit/verify** See the description in Code 39.
- **Data Magic** Turn on or turn off Data Magic.
- **Max/Min code length** See the description in Code 39.
- **Truncate leading/ending** See the description in UPC-A.
- **Code ID setting** See the description in UPC-A.



Setting	Option	Value
 *EAA*	Disable	00*
Read	Enable	01
 *EAB*	Disable/Disable	00*
Checksum	Disable/Enable	01
transmit/verifiy	Enable /Enable	02
 *EAC*	Disable	00*
Data Magic	Enable	01

Setting	Option	Value
 *EAD*	00-64	00-64
Max. code length		00*
 *EAE*	00-64	00-64
Min. code length		00*
 *EAF*	0-15	00-15
Truncate leading		00*
 *EAG*	0-15	00-15
Truncate ending		00*
 *EAH*	00-ffH ASCII code	00-ffH
Code ID setting		< % > *





%\$\$

Exit

- **Insertion group number selection** See the description in UPC-A.
- **Start/End type** Codabar has four pairs of characters for the star and stop codes. Select one pair to suit your needs.
- **Start/End transmission**
See the description in Code 39.



Setting	Option	Value
 *EAI* Insert group number selection	00-44	00-44
		00*
 *EAJ* Start/End type	ABCD/ABCD	00*
	abcd/abcd	01
	ABCD/TN*E	02
	abcd/tn*e	03
 *EAK* Start/End transmission	Disable	00*
	Enable	01



Code 128 / GS1-128

Format



Data Digits (Variable)	Checksum (Optional)
---------------------------	------------------------

- **Read** Turn on or turn off the read function.
- **Checksum transmit/verify** See the description in Code 39.
- **Data Magic** Turn on or turn off Data Magic.



\$%+PRO

Program

Setting	Option	Value
 *DAA* Read	Disable	00
	Enable	01*
 *DAB* Checksum	Disable/Disable	00*
	Disable/Enable	01
Transmit/Verify	Enable /Enable	02
	 *DAC* Data Magic	Disable
	Enable	01



%\$\$

Exit

- **Max/Min code length** See the description in Code 39.
- **Truncate leading/ending** See the description in UPC-A.
- **Code ID setting** See the description in UPC-A.







- Format** It converts Code 128 to UCC/EAN-128(GS1-128) if the bar code starts with the FNC1 character. The first FNC1 is translated to “]C1,” and the next one is translated to a field separator, which is ASCII code 29, <GS>.

]C1	Data	<GS>	Data	Checksum
-----	------	------	------	----------



\$%+PRO

Program

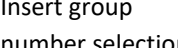
Setting	Option	Value
 *DAD*	00-64	00-64 00*
Max. code length		
 *DAE*	00-64	00-64 01*
Min. code length		
 *DAF*	0-15	00-15 00*
Truncate leading		
 *DAG*	0-15	00-15 00*
Truncate ending		
 *DAH*	00-ffH ASCII code	00-ffH < # >*
Code ID setting		
 *DAI*	00-44	00-44 00*
Insert group number selection		
 *DAJ*	Standard UCC/EAN-128	00 01*
Format		



%\$\$

Exit

- **Append** It decodes and concatenates several Code 128 bar codes that have the FNC2 character at their beginning. Your scanner stops concatenating and sends all concatenated data to your computer when it decodes a bar code that doesn't have an FNC2 character at its beginning, or when it decodes a bar code that is not Code 128.
- **ISBT enable** Enable or disable ISBN barcode readable.
- **Field separator code** It is used for the bar codes converted to UCC/EAN 128 only. You can use the ASCII code to customize your field separator. The default separator is <GS>.
- **GS1-128 ID** See the description in UPC-A.



\$%+PRO

Program

Setting	Option	Value
Append	Disable/Enable	00*
	Enable/Disable	01
	Disable/Ignore	02
	Enable/ Ignore	03
ISBT enable	00-ffH ASCII code	00-ffH < # >*
	1DH*	
Field separator code	00-ffH ASCII code	00-ffH 1DH*
	Default	
GS1-128 ID	00-ffH ASCII code	00-ffH Default
	: #	



%\$\$

Exit

Code 93

Format



Data Digits (Variable)	Checksum1 (Optional)	Checksum2 (Optional)
---------------------------	-------------------------	-------------------------

- **Read** Turn on or turn off the read function.
- **Checksum transmit/verify** See the description in Code 39.
- **Data Magic** Turn on or turn off Data Magic.



\$%+PRO

Program

Setting	Option	Value
 *CAA* Read	Disable	00*
	Enable	01
 *CAB* Checksum transmit/verify	Disable/Disable	00*
	Disable/Enable	01
	Enable /Enable	02
 *CAC* Data Magic	Disable	00*
	Enable	01



%\$\$

Exit

- **Max/Min code length** See the description in Code 39.
- **Truncate leading/ending** See the description in UPC-A.
- **Code ID setting** See the description in UPC-A.
- **Insertion group number selection** See the description in UPC-A.



\$%+PRO

Program

Setting	Option	Value
 *CAD*	00-64	00-64
Max. code length		00*
 *CAE*	00-64	00-64
Min. code length		00*
 *CAF*	0-15	00-15
Truncate leading		00*
 *CAG*	0-15	00-15
Truncate ending		00*
 *CAH*	00-ffH ASCII code	00-ffH
Code ID setting		< & >*
 *CAI*	00-44	00-44
Insert group number selection		00*



%\$\$

Exit

Code 11

Format



Data Digits (Variable)	Checksum1 (Optional)	Checksum2 (Optional)
---------------------------	-------------------------	-------------------------







- **Read** Turn on or turn off the read function.
- **Checksum transmit/verify** See the description in Code 39.
- **Data Magic** Turn on or turn off Data Magic.
- **Max/Min code length** See the description in Code 39.
- **Truncate leading/ending** See the description in UPC-A.
- **Code ID setting** See the description in UPC-A.
- **Insertion group number selection** See the description in UPC-A.



\$%+PRO

Program

Setting	Option	Value
 *AAA* Read	Disable	00*
	Enable	01
 *AAB* Checksum transmit/verify	Disable/Disable	00
	Disable/One digit	01*
	Disable/Two digits	02
	Enable/One digit	03
	Enable/Two digits	04

Setting	Option	Value
 *AAC* Data Magic	Disable	00*
	Enable	01
 *AAD* Max. code length	00-64	00-64
		00*
 *AAE* Min. code length	00-64	00-64
		00*
 *AAF* Truncate leading	0-15	00-15
		00*
 *AAG* Truncate ending	0-15	00-15
		00*
 *AAH* Code ID setting	00-ffH ASCII code	00-ffH
		< O >*
 *AAI* Insert group number selection	00-44	00-44
		00*



%\$\$

Exit

MSI/Plessey

Format

Data Digits (Variable)	Checksum1 (Optional)	Checksum2 (Optional)
---------------------------	-------------------------	-------------------------

- **Read** Turn on or turn off the read function.
- **Checksum transmit/verify** There are three algorithms for you to calculate the check digit of a MSI bar code: MOD 10, MOD 10/MOD 10, MOD 11/MOD 10. For example, if you choose MOD 11/MOD 10, the system uses MOD 11 to calculate the check digit and append it to the bar code. The new bar code with the MOD 11 check digit will be calculated again using MOD 10, and then the system appends the MOD 10 check digit to the new bar code. The result of the bar code format is:
<DATA><MOD 11 check digit><MOD 10 check digit>
- **Data Magic** Turn on or turn off Data Magic.
- **Max/Min code length** See the description in Code 39.
- **Truncate leading/ending** See the description in UPC-A.
- **Code ID setting** See the description in UPC-A.
- **Insertion group number selection** See the description in UPC-A.











\$%+PRO

Program

Setting	Option	Value
 *KAA*	Disable	00*
	Enable	01

Read

Setting	Option	Value
 *KAB* Checksum transmit/verify	N/disable	00*
	N/MOD 10	01
	N/Mod 10,10	02
	N/mod 11,10	03
	Y/ Mod10	04
	Y/ Mod 10,10	05
	Y/ Mod 11/10	06
 *KAC* Data Magic	Disable	00*
	Enable	01
 *KAD* Max. code length	00-64	00-64 00*
 *KAE* Min. code length	00-64	00-64 00*
 *KAF* Truncate leading	0-15	00-15 00*
 *KAG* Truncate ending	0-15	00-15 00*
 *KAH* Code ID setting	00-ffH ASCII code	00-ffH < @ >*
 *KAI* Insert group number selection	00-44	00-44 00*



%\$\$

Exit

UK/Plessey

Format



Data Digits (Variable)	Checksum1+2 (Optional)
---------------------------	---------------------------







- **Read** Turn on or turn off the read function.
- **Checksum transmit/verify** UK/Plessey has two checksums. The first is calculated using modulo 10 and the second is calculated using modulo 11.
- **Data Magic** Turn on or turn off Data Magic.
- **Max/Min code length** See the description in Code 39.
- **Truncate leading/ending** See the description in UPC-A.
- **Code ID setting** See the description in UPC-A.
- **Insertion group number selection** See the description in UPC-A.



\$%+PRO

Program

Setting	Option	Value
 *LAA* Read	Disable	00*
	Enable	01
 *LAB* Checksum transmit/verify	Disable/Disable	00
	Disable/Enable	01*
	Enable/Enable	02

Setting	Option	Value
 *LAC*	Disable	00*
Data Magic	Enable	01
 *LAD*	00-64	00-64
Max. code length		00*
 *LAE*	00-64	00-64
Min. code length		00*
 *LAF*	0-15	00-15
Truncate leading		00*
 *LAG*	0-15	00-15
Truncate ending		00*
 *LAH*	00-ffH ASCII code	00-ffH
Code ID setting		< @ >*
 *LAI*	00-44	00-44
Insert group number selection		00*







%\$\$

Exit

Telepen

- **Read** Turn on or turn off the read function.
- **Checksum transmit/verify** See the description in UK/Plessey.
- **Data Magic** Turn on or turn off Data Magic.
- **Max/Min code length** See the description in Code 39.
- **Truncate leading/ending** See the description in UPC-A.
- **Code ID setting** See the description in UPC-A.
- **Insertion group number selection** See the description in UPC-A.



Setting	Option	Value
 * M A A * Read	Disable	00*
	Enable	01
 * M A B * Checksum transmit/verify	Disable/Disable	00*
	Disable/Enable	01
	Enable /Enable	02
 * M A C * Data Magic	Disable	00*
	Enable	01
 * M A D * Max. code length	00-64	00-64
		00*

Setting	Option	Value
 *MAE*	00-64	00-64
Min. code length		00*
 *MAF*	0-15	00-15
Truncate leading		00*
 *MAG*	0-15	00-15
Truncate ending		00*
 *MAH*	00-ffH ASCII code	00-ffH
Code ID setting		< S >*
 *MAI*	00-44	00-44
Insert group		00*
number selection		
 *MAJ*	Numeric only	00*
Format	Full ASCII only	01



%\$\$

Exit

Standard 2 of 5

Format



Data Digits (Variable)	Checksum1 (Optional)
---------------------------	-------------------------







- **Read** Turn on or turn off the read function.
- **Checksum transmit/verify** The checksum is calculated using modulo 10.
- **Data Magic** Turn on or turn off Data Magic.
- **Max/Min code length** See the description in Code 39.
- **Truncate leading/ending** See the description in UPC-A.
- **Code ID setting** See the description in UPC-A.
- **Insertion group number selection** See the description in UPC-A.



\$%+PRO

Program

Setting	Option	Value
 *JAA* Read	Disable	00*
	Enable	01
 *JAB* Check-sum transmit/verify	Disable/Disable	00*
	Disable/Enable	01
	Enable /Enable	02
 *JAC* Data Magic	Disable	00*
	Enable	01

Setting	Option	Value
 *JAD*	00-64	00-64
Max. code length		00*
 *JAE*	00-64	00-64
Min. code length		00*
 *JAF*	0-15	00-15
Truncate leading		00*
 *JAG*	0-15	00-15
Truncate ending		00*
 *JAH*	00-ffH ASCII code	00-ffH
Code ID setting		< i >*
 *JAI*	00-44	00-44
Insert group number selection		00*



%\$\$

Exit





China Post



Format

Data Digits (Variable)	Checksum1 (Optional)
---------------------------	-------------------------

- **Read** Turn on or turn off the read function.
- **Data Magic** Turn on or turn off Data Magic.
- **Max/Min code length** See the description in Code 39.
- **Truncate leading/ending** See the description in UPC-A.
- **Code ID setting** See the description in UPC-A.
- **Insertion group number selection** See the description in UPC-A.



Setting	Option	Value
 *SAA* Read	Disable	00*
	Enable	01
 *SAC* Data Magic	Disable	00*
	Enable	01
 *SAD* Max. code length	00-64	00-64
		11*
 *SAE* Min. code length	00-64	00-64
		11*

Setting	Option	Value
 *SAF*	0-15	00-15
Truncate leading		00*
 *SAG*	0-15	00-15
Truncate ending		00*
 *SAH*	00-ffH ASCII code	00-ffH
Code ID setting		< t >*
 *SAI*	00-44	00-44
Insert group number selection		00*



%\$\$

Exit



Italian Pharmacode (Code 32)

Format

Data Digits (Variable)	Checksum1 (Optional)
---------------------------	-------------------------

- **Read** Turn on or turn off the read function.
- **Data Magic** Turn on or turn off Data Magic.
- **Max/Min code length** See the description in Code 39.
- **Truncate leading/ending** See the description in UPC-A.
- **Code ID setting** See the description in UPC-A.
- **Insertion group number selection** See the description in UPC-A.
- **Leading “A”** Add the character “A” at the beginning of a Code 32 bar code.



Setting	Option	Value
 *WAA* Read	Disable	00*
	Enable	01
 *WAC* Data Magic	Disable	00*
	Enable	01
 *WAD* Max. code length	00-64	00-64
		12*

Setting	Option	Value
 *WAE*	00-64	00-64
Min. code length		09*
 *WAF*	0-15	00-15
Truncate leading		00*
 *WAG*	0-15	00-15
Truncate ending		00*
 *WAH*	00-ffH ASCII code	01-ffH
Code ID setting		< p >*
 *WAI*	00-44	00-44
Insert group number selection		00*
 *WAJ*	Disable	00*
Leading "A"	Enable	01



%\$\$

Exit







Code 16K

- **Read** Turn on or turn off the read function.
- **Data Magic** Turn on or turn off Data Magic.
- **Truncate leading/ending** See the description in UPC-A.
- **Code ID setting** See the description in UPC-A.
- **Insertion group number selection** See the description in UPC-A.



\$%+PRO

Program

Setting	Option	Value
 *RAA* Read	Disable	00*
	Enable	01
 *RAC* Data Magic	Disable	00*
	Enable	01
 *RAF* Truncate leading	0-15	00-15
		00*
 *RAG* Truncate ending	0-15	00-15
		00*
 *RAH* Code ID setting	00-ffH ASCII code	00-ffH
		< >*
 *RAI* Insert group	00-44	00-ffH
		00-44
number selection		00*



%\$\$



Exit

EAN UCC Composite

- **Read** Turn on or turn off the read function.
- **Data Magic** Turn on or turn off Data Magic.
- **Max/Min code length** See the description in Code 39.
- **Code ID setting** See the description in UPC-A.
- **Insertion group number selection** See the description in UPC-A.
- **UCC/EAN 128 emulation** See the description in GS1 Databar Omnidirectional.



Setting	Option	Value
 YAA Read	Disable	00*
	Enable	01
 YAC Data Magic	Disable	00*
	Enable	01
 YAF Truncate leading	0-15	00-15
		00*
 YAG Truncate ending	0-15	00-15
		00*

Setting	Option	Value
 *YAH*	00-ffH	00-ffH
Code ID setting	ASCII code	< RC >*
 *YAI*	00-44	00-44
Insert group number selection		00*
 *YAK*	Disable	00*
UCC / EAN128 emulation	Enable	01



%\$\$

Exit

GS1 Databar Omnidirectional



Format





Data Digits (Variable)	Checksum1 (Optional)
---------------------------	-------------------------

- **Read** Turn on or turn off the read function.
- **Data Magic** Turn on or turn off Data Magic.
- **Truncate leading/ending** See the description in UPC-A.
- **Code ID setting** See the description in UPC-A.
- **Insertion group number selection** See the description in UPC-A.
- **UCC/EAN 128 emulation** It adds “[C1” at the beginning of a GS1 bar code. You need to turn on AIM ID to use this feature. For more information about AIM ID, see Section 3.4.4, [ID, name and capitalization](#).



Program

Setting	Option	Value
 *TAA* Read	Disable	00*
	Enable	01
 *TAC* Data Magic	Disable	00*
	Enable	01
 *TAF* Truncate leading	0-15	00-15
		00*

Setting	Option	Value
 *TAG* Truncate ending	0-15	00-15
		00*
 *TAH* Code ID setting	00-ffH ASCII code	00-ffH
		< R4 >*
 *TAI* Insert group number selection	00-44	00-44
		00*
 *TAK* UCC/EAN128 emulation	Disable	00*
	Enable	01

 %\$\$ Exit

GS1 Databar Limited





Format

Data Digits (Variable)	Checksum1 (Optional)
---------------------------	-------------------------

- **Read** Turn on or turn off the read function.
- **Data Magic** Turn on or turn off Data Magic.
- **Code ID setting** See the description in UPC-A.
- **Insertion group number selection** See the description in UPC-A.
- **UCC/EAN 128 emulation** See the description in GS1 Databar Omnidirectional.



Setting	Option	Value
 *UAA*	Disable	00*
	Enable	01
Read		
 *UAC*	Disable	00*
	Enable	01
Data Magic		
 *UAD*	00-64	00-64
Max. code length		
 *UAE*	00-64	00-64
Min. code length		

Setting	Option	Value
 *UAF*	0-15	00-15 00*
Truncate leading		
 *UAG*	0-15	00-15 00*
Truncate ending		
 *UAH*	00-ffH ASCII code	00-ffH < RL >*
Code ID setting		
 *UAI*	00-44	00-44 00*
Insert group number selection		
 *UAK*	Disable Enable	00* 01
UCC/EAN128 emulation		

%\$\$ Exit



GS1 Databar Expanded







Format

Data Digits (Variable)	Checksum1 (Optional)
---------------------------	-------------------------

- **Read** Turn on or turn off the read function.
- **Data Magic** Turn on or turn off Data Magic.
- **Max/Min code length** See the description in Code 39.
- **Code ID setting** See the description in UPC-A.
- **Insertion group number selection** See the description in UPC-A.
- **UCC/EAN 128 emulation** See the description in GS1 Databar Omnidirectional.



Setting	Option	Value
 *VAA*	Disable	00*
	Enable	01
Read  *VAC*	Disable	00*
	Enable	01
Data Magic  *VAD*	00-99	00-99
	Max. code length	99*

Setting	Option	Value
 *VAE*	00-99	00-99
Min. code length		01*
 *VAF*	0-15	00-15
Truncate leading		00*
 *VAG*	0-15	00-15
Truncate ending		00*
 *VAH*	00-ffH ASCII code	00-ffH
Code ID setting		< RX >*
 *VAI*	00-44	00-44
Insert group number selection		00*
 *VAK*	Disable	00*
UCC/EAN128 emulation	Enable	01



%\$\$

Exit

5 Troubleshooting

You might encounter some issues when you scan bar codes. This chapter provides information that helps you fix common issues.

5.1 Scanner issues

My scanner doesn't emit the aiming pattern.

- Your scanner is sending data to your computer. Wait until it finishes.
- Did you plug the connection cable to your computer?

5.2 Bar code issues

My scanner doesn't read the bar code properly.

- Reset your scanner.
- Check the quality of your bar codes. Wrinkled, smudged, blurred or torn bar codes won't be read by your scanner.
- The reading window of your scanner may be dirty and block the field of view. Clean the reading window.

The data isn't sent to my computer.

- Make sure the USB or RS-232 cable is tightly plugged into your computer.

My scanner doesn't decode the bar code, but the bar code type is supported.

- Did you turn on **Read** for the bar code type?
- The density of your bar code may be too high for your scanner to decode.

6 Specifications

PERFORMANCE CHARACTERISTICS

Model	AI-6800
Light Source	Red LED
Sight	Red LED, 623 nm
Scan Pattern	Linear Imager(CCD)
Indicator	LED & beeper
Interface	USB (HID/Virtual COM), RS-232
Scan Angle	39°
Print Contrast	15%
Scan Rate	700 scans/sec
D.O.F.	
3mil	55 ~ 85mm
4 mil	55 ~115mm
5mil	50 ~135mm
10mil	35 ~310mm
13mil	40 ~410mm
20mil	45 ~565mm
EAN13, 13mil	40 ~ 355mm

Electrical

Input voltage	5V DC \pm 5%
Power - operating	215mA @ 5VDC Max(USB)
Power - standby	52mA @5VDC Typical(USB)

PHYSICAL CHARACTERISTICS

Dimensions	9.4 x 7.6 x 15.8 cm
Weight	140 g

SYMBOLGY DECODE CAPABILITY

Linear	Code11,Code39,Code93,Code32(Pharmaceutical),Code128,Codabar, Interleaved 2of 5,Industrial 2 of 5,IATA 2 of 5,Matrix 2of5,EAN/JAN-13,EAN/JAN-8,UPC-A , UPC-E,UPC-A/EAN-13 with Extended Coupon code, Tele pen, Plessey Code, GS1 Databar RSS14, GS1 Databar Limited,GS1 Databar,Omni directional, GS1 Databar Expanded ,China Post
Stacked Linear	GS1 Databar Expanded Stacked,GS1 Databar RSS14 Stacked, C16K, CodaBlockF

USER ENVIRONMENT

Operating Temperature	-20°C to 60°C (-4°F to 140°F)
Storage Temperature	-30°C to 70°C (-22°F to 158°F)
Humidity	5% to 95% related humidity, non-condensing
Drop Specifications	6 ft./1.8 m drop
Contaminants	Seals to resist airborne particulate contaminants (IP65)
Light level	0 ~ 100,000 lux 0 ~ 100,000 lux

REGULATORY

EMI/RFI	CE, FCC, BSMI
----------------	---------------

6.1 Pin Assignments

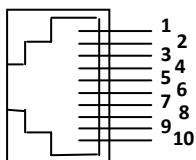

10 pin

10-pin RJ45 Connector

Pin	RS-232	USB
1	NC	NC
2	VCC (+5V)	VCC (+5V)
3	TXD	NA
4	NA	USB_D+
5	NA	USB_D-
6	CTS	NA
7	RX	NA
8	RTS	NA
9	GND	GND
10	GND	GND

Appendix A. Test symbologies

Bar codes marked with asterisk (*) are turned on initially.

CODABAR



a154987a

CODE 11



654215

CODE-128 *



258963

CODE-39 *



741258

CODE-93



951263

EAN-13 *

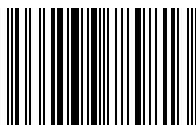

7 534539 789813

STANDARD 2 of 5



65978

CODE 16K



87549

EAN-8 *



9456 2156

INDUSTRIAL 2 of 5



04976

UPC-E *



0 095601 1

INTERLEAVED 2 of 5 *



46820

MATRIX 2 of 5



MSI/PLESSEY



UPC-A *



UK/PLESSEY



GS1



Appendix B. ASCII table

L \ H	0	1	0	1
0	Null		NUL	DLE
1	Up	F1	SOH	DC1
2	Down	F2	STX	DC2
3	Left	F3	ETX	DC3
4	Right	F4	EOT	DC4
5	PgUp	F5	ENQ	NAK
6	PgDn	F6	ACK	SYN
7		F7	BEL	ETB
8	Bs	F8	BS	CAN
9	Tab	F9	HT	EM
A		F10	LF	SUB
B	Home	Esc	VT	ESC
C	End	F11	FF	FS
D	Enter	F12	CR	GS
E	Insert	Ctrl+	SO	RS
F	Delete	Alt+	SI	US

L \ H	2	3	4	5	6	7
0	SP	0	@	P	`	p
1	!	1	A	Q	a	q
2	"	2	B	R	b	r
3	#	3	C	S	c	s
4	\$	4	D	T	d	t
5	%	5	E	U	e	u
6	&	6	F	V	f	v
7	'	7	G	W	g	w
8	(8	H	X	h	x
9)	9	I	Y	i	y
A	★	:	J	Z	j	z
B	+	;	K	[k	{
C	,	<	L	\	l	
D	-	=	M]	m	}
E	.	>	N	^	n	~
F	/	?	O	_	o	DEL

Appendix C. Default settings of bar codes

Code Type	Read	Checksum Verification	Checksum Transmission	Code ID
UPC-A	V	V	V	A
UPC-E	V	V	V	E
EAN-13	V	V	V	F
EAN-8	V	V	V	FF
Code 39	V			*
Interleaved 2 of 5	V			i
Industrial 2 of 5		-	-	i
Matrix 2 of 5				B
Codabar				%
Code 128	V	V		#
Code 93		V two digits		&
Code 11		V One digit		O
MSI/Plessey		V		@
UK/Plessey		V		@
Telepen				S
Standard 2 of 5		-	-	i
China Post				t
Italian Pharmacode				p
Code 16K		-	-	
EAN UCC Composite		-	-	RC
GS1 databar Omnidirectional		-	-	R4
GS1 databar Limited		-	-	RL

Code Type	Read	Checksum Verification	Checksum Transmission	Code ID
GS1 databar Expanded		-	-	RX

Appendix D. Data entry bar codes



/0

0



/A

A



/1

1



/B

B



/2

2



/C

C



/3

3



/D

D



/4

4



/E

E



/5

5



/F

F



/6

6



/7

7



/9

9



/8

8



/%%*

Finish